

# CHM<sup>®</sup>

CHARSPINE *system 2*

## SPINE STABILIZATION

- *IMPLANTS*
- *INSTRUMENT SET 15.0907.001*
- *INSTRUMENT SET 15.0907.002*
- *ADDITIONAL INSTRUMENTS*
- *SURGICAL TECHNIQUE*



#### SYMBOLS DESCRIPTION



Caution - pay attention to a special procedure.



Perform the activity under X-Ray control.



Information about the next stages of a procedure.



Proceed to the next stage.



Return to the specified stage and repeat the activity.



Before using the product, carefully read the Instructions for Use. It contains, among others, indications, contraindications, side effects, recommendations and warnings related to the use of the product.



The above description is not a detailed instruction of conduct. The surgeon decides about choosing the operating procedure.

---

1. INTRODUCTION	5
2. IMPLANTS	9
3. INSTRUMENTS	38
3.1. CONTAINERS ARRANGEMENT	46
4. SURGICAL TECHNIQUE	49
4.1. THORACOTOMY	49
4.2. ANTERIOR THORACOLUMBAR APPROACH	50
4.3. ANTERIOR RETROPERITONEAL APPROACH	50
4.4. POSTERIOR APPROACH TO THE THORACOLUMBAR APPROACH	51
4.5. APPROACH TO POSTERIOR SUPERIOR ILIAC SPINE	51
4.6. SCREW SELECTION. PREPARATION OF THE SCREW ENTRY POINT	52
4.7. INSERTION OF SCREWS. POSTERIOR APPROACH	53
4.8. INTRODUCTION OF POLYAXIAL SCREWS INTO THE PELVIS	70
4.9. HOOKS INSERTION	72
4.10. INSERTION OF SCREWS - ANTEROLATERAL APPROACH	75
4.11. IMPLANT REMOVAL	78
4.12. CEMENT AUGMENTATION OF SCREWS ( <i>OPTIONAL</i> )	79



## 1. INTRODUCTION

**CHARSPINE2** Thoracolumbar Spinal Stabilization System is the set of universal spinal fixation implants for thoracolumbar and lumbar spine treatment in skeletally mature patients:

- via posterior approach
  - screw fixation from T1 (T3) to S2
  - hook fixation from T1 (T3) to L5
- via anterolateral approach
  - screw fixation from T4 (T6) to L4 (L3)

**CHARSPINE2** system consists of:

- implants (*screws, hooks, connectors, locking elements, staples, and others*),
- instruments for implants insertion,
- instructions for use and surgical technique.

### INDICATIONS

**CHARSPINE2** implants allow for treatment intended for spinal physiological curvature reconstruction by means of appropriate vertebrae reposition.

Indications for use:

- degenerative disc disease,
- spondylolistheses,
- fractures and instabilities,
- deformities (*e.g. scolioses or kyphoses*),
- tumours,
- stenoses,
- pseudoarthroses,
- nonunion following the previous procedures.

### CONTRAINDICATIONS

Contraindications may be relative and absolute. One should thoroughly consider the selection of an appropriate implant on the basis of comprehensive assessment of patient's health condition. Some conditions such as spinal infection, morbid obesity, mental disease, alcohol or drug addiction, pregnancy, oversensitivity to metals/foreign bodies, insufficient tissue coverage or open wound in the operative site may reduce the chances of surgery or make the success impossible.



A detailed list of contraindications is presented in instructions for use (IFU) intended for this device.

### WARNINGS

Safety and effectiveness of spinal systems based upon pedicle screw fixation have been established only for pathological spinal conditions caused by significant mechanical instability or deformations requiring surgical fixation.

Safety and effectiveness of these systems for any other conditions are unknown.

It is not always possible to achieve positive results in each and every patient. This especially applies to procedures in which other conditions related to patient's state may make it impossible to achieve the positive results.

The final result is greatly influenced by appropriate patient selection and patient's observance of post-operative recommendations. It is proved that smoking hampers the bone union. Patients should be informed about this correlation and warned about the consequences.



A detailed list of warnings, precautions and postoperative recommendations is presented in instructions for use (IFU) intended for this device.

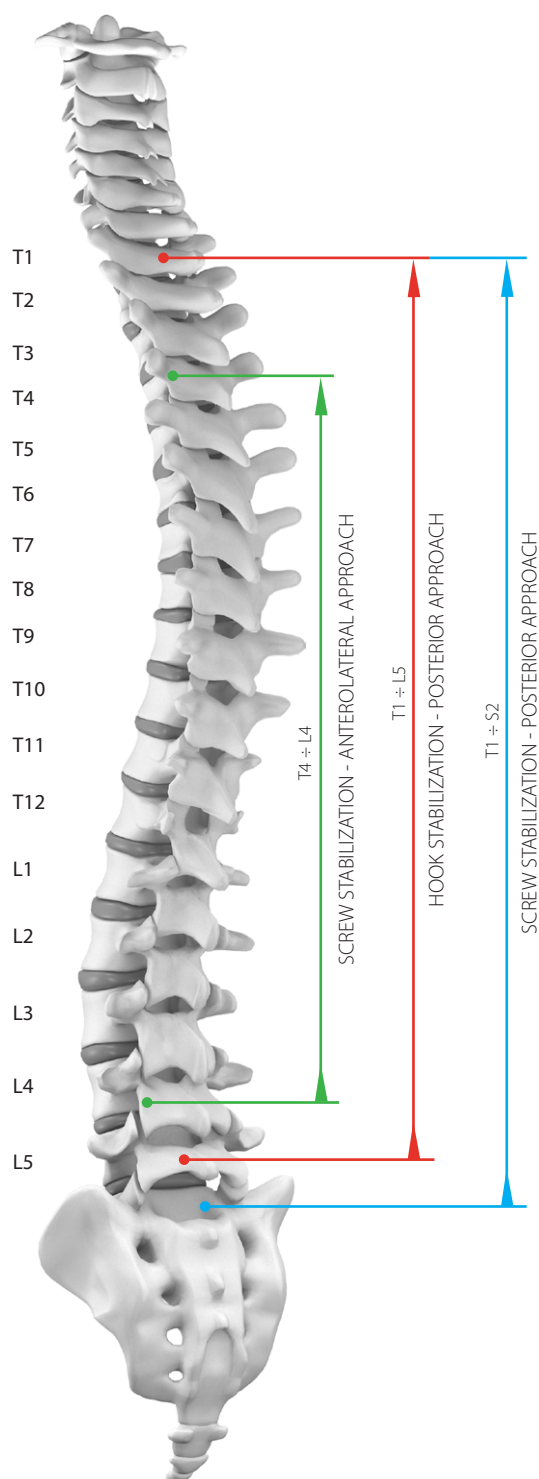



Implants from the ChM CHARSPINE2 spine stabilization system are designed and tested to be used only with the appropriate ChM instrument set. This surgical technique is intended as a guide only. As with any surgical procedure, the surgeon should be thoroughly trained before the procedure and must take into consideration the particular needs of each patient.

**MAIN FEATURES AND BENEFITS**

Presented implants and instrument set are intended for posterior and anterolateral approach.

The presented range of implants is made of titanium, titanium alloys and cobalt alloy in accordance with ISO 5832 standards.

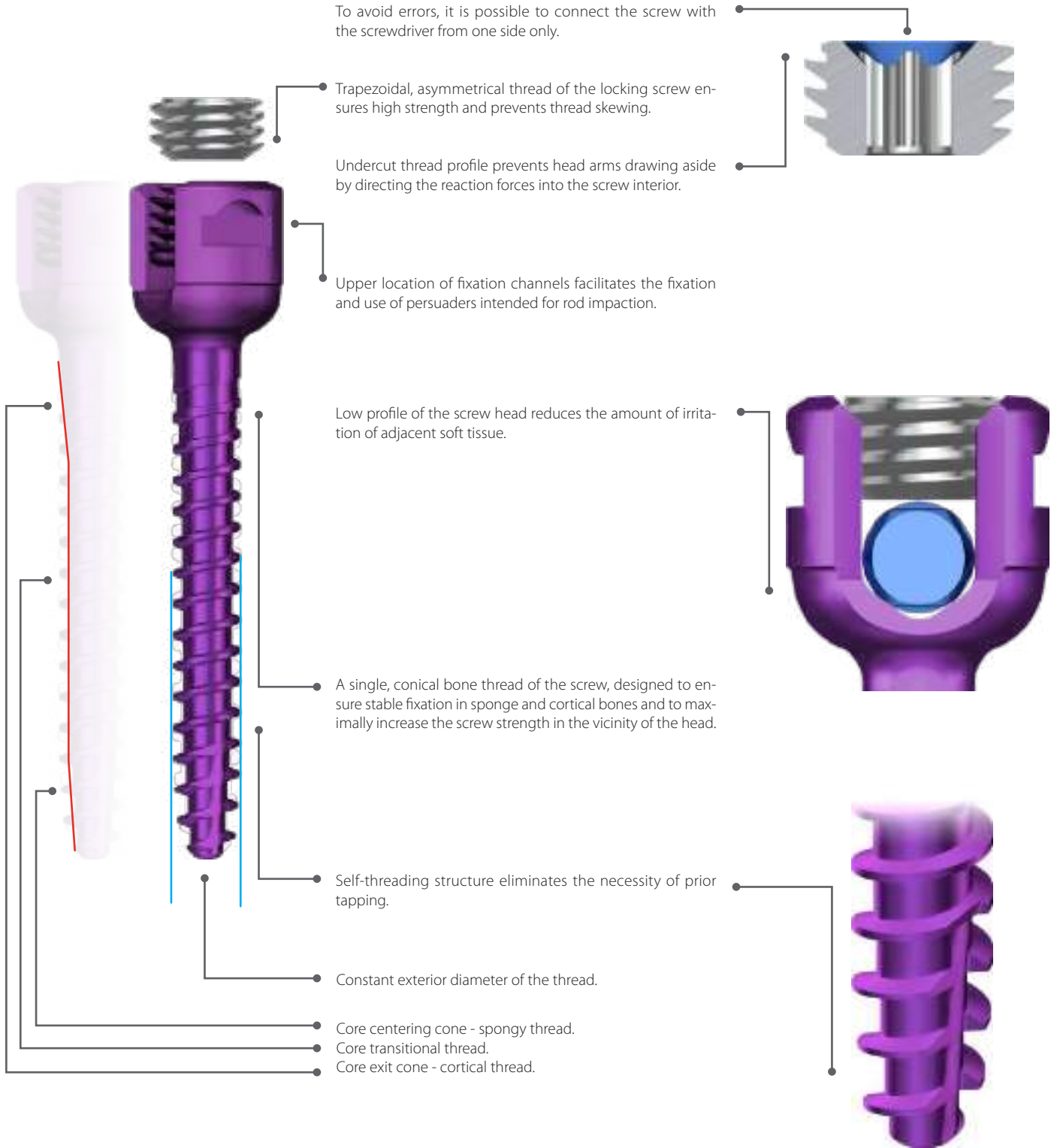

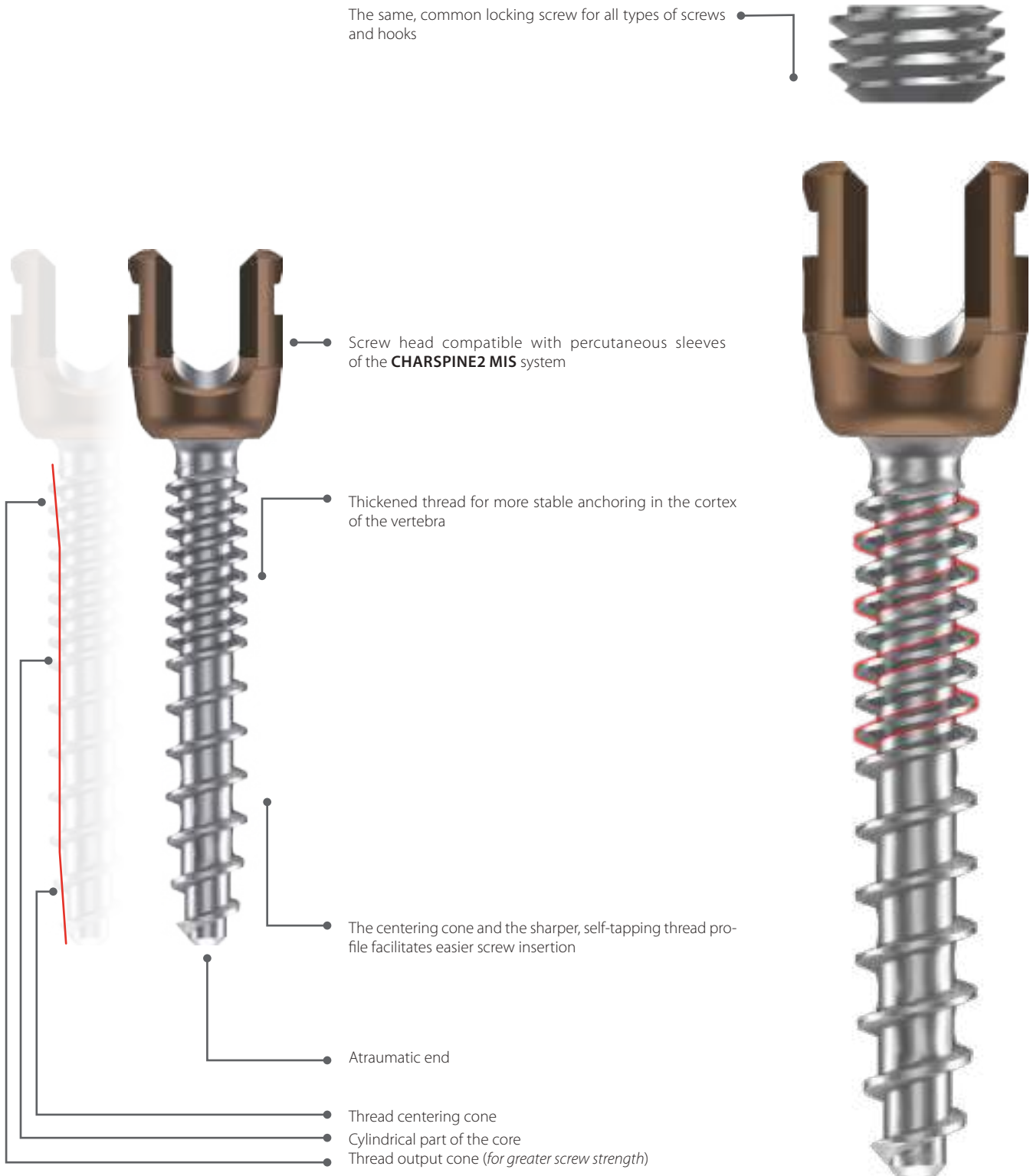

The screws with a double thread of CHARSPINE2 system are compatible with the instrument set 15.0913 for minimally invasive technique (MIS). Should these screws be introduced using percutaneous method (without the use of a guide rod), please refer to the surgical technique No. ST-86, intended for the CHARSPINE2 MIS system.

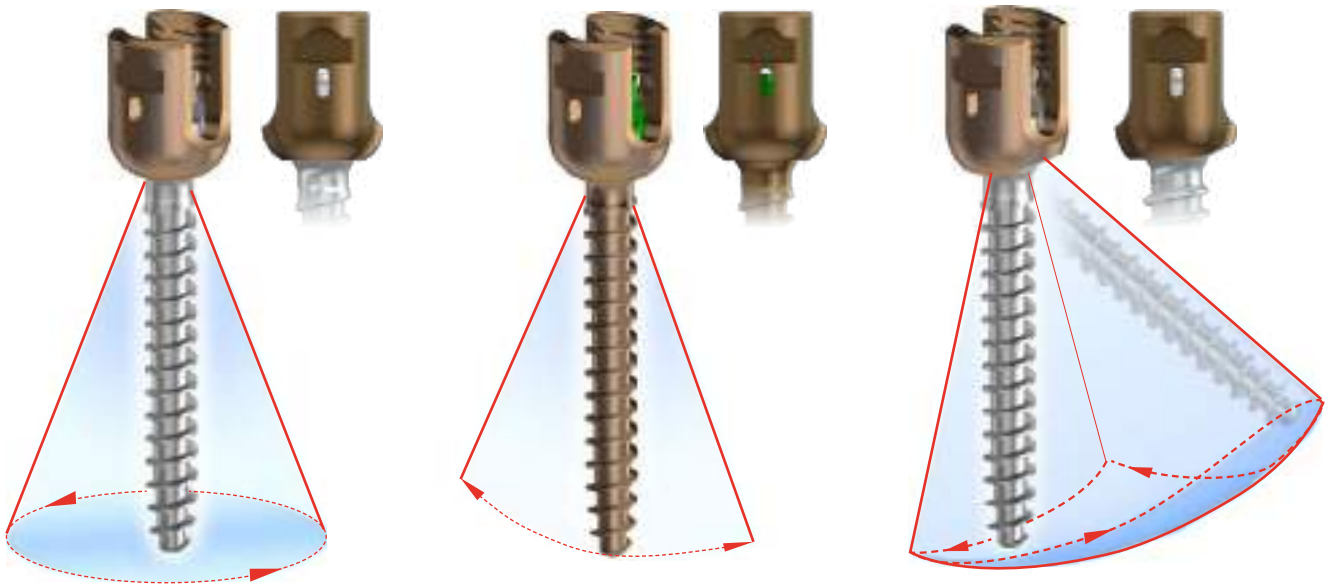

**Polyaxial screws** allow for stable angular fixation of the screw head in each direction.

**Uniplanar screws** combine the features of medial-lateral stiffness of monoaxial screws with the mobility of polyaxial screws in the rostral-caudal direction.

**Polyaxial screws for pelvis** allow for the extension of thoracolumbar spine stabilization and fixation in the pelvic bone. The screws offer an increased asymmetrical range of motion in one of the planes, facilitating the rod-to-screw fixation.

A new generation of surgical instruments was prepared for **CHARSPINE2** system, aiming at maximization of their ergonomics, functionality and effectiveness.

The instruments have original **ChM** branded silicon handles that improve the ergonomics and comfort of a grip.





2. IMPLANTS

CHARSPINE2 MONOAXIAL SCREW

CHARSPINE system 2



	Len	Ti		Len	Ti
4.0	25	3.6150.125	8.5	25	3.6157.125
	30	3.6150.130		30	3.6157.130
	35	3.6150.135		35	3.6157.135
	40	3.6150.140		40	3.6157.140
	45	3.6150.145		45	3.6157.145
4.5	25	3.6151.125	50	3.6157.150	
	30	3.6151.130	55	3.6157.155	
	35	3.6151.135	60	3.6157.160	
	40	3.6151.140	65	3.6157.165	
	45	3.6151.145	70	3.6157.170	
5.0	25	3.6152.125	75	3.6157.175	
	30	3.6152.130	80	3.6157.180	
	35	3.6152.135	85	3.6157.185	
	40	3.6152.140	90	3.6157.190	
	45	3.6152.145	95	3.6157.195	
5.5	50	3.6152.150	100	3.6157.001	
	25	3.6153.125	25	3.6158.125	
	30	3.6153.130	30	3.6158.130	
	35	3.6153.135	35	3.6158.135	
	40	3.6153.140	40	3.6158.140	
6.0	45	3.6153.145	45	3.6158.145	
	50	3.6153.150	50	3.6158.150	
	55	3.6153.155	55	3.6158.155	
	25	3.6154.125	60	3.6158.160	
	30	3.6154.130	65	3.6158.165	
6.5	35	3.6154.135	70	3.6158.170	
	40	3.6154.140	75	3.6158.175	
	45	3.6154.145	80	3.6158.180	
	50	3.6154.150	85	3.6158.185	
	55	3.6154.155	90	3.6158.190	
7.0	60	3.6154.160	95	3.6158.195	
	65	3.6154.165	100	3.6158.001	
	25	3.6155.125	25	3.6159.125	
	30	3.6155.130	30	3.6159.130	
	35	3.6155.135	35	3.6159.135	
7.5	40	3.6155.140	40	3.6159.140	
	45	3.6155.145	45	3.6159.145	
	50	3.6155.150	50	3.6159.150	
	55	3.6155.155	55	3.6159.155	
	60	3.6155.160	60	3.6159.160	
8.0	65	3.6155.165	65	3.6159.165	
	70	3.6155.170	70	3.6159.170	
	75	3.6155.175	75	3.6159.175	
	80	3.6155.180	80	3.6159.180	
	85	3.6155.185	85	3.6159.185	
8.5	90	3.6155.190	90	3.6159.190	
	95	3.6155.195	95	3.6159.195	
	100	3.6155.001	100	3.6159.001	
	25	3.6156.125	70	3.6159.170	
	30	3.6156.130	75	3.6159.175	
9.0	35	3.6156.135	80	3.6159.180	
	40	3.6156.140	85	3.6159.185	
	45	3.6156.145	90	3.6159.190	
	50	3.6156.150	95	3.6159.195	
	55	3.6156.155	100	3.6159.001	
9.5	60	3.6156.160			
	65	3.6156.165			
	70	3.6156.170			
	75	3.6156.175			
	80	3.6156.180			
10.0	85	3.6156.185			
	90	3.6156.190			
	95	3.6156.195			
	100	3.6156.001			
	25	3.6156.125			
10.5	30	3.6156.130			
	35	3.6156.135			
	40	3.6156.140			
	45	3.6156.145			
	50	3.6156.150			

CHARSPINE2 LOCKING SCREW

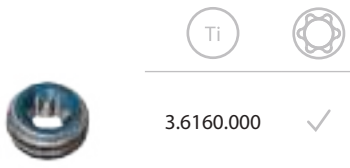

Ø4.0 Ø4.5 Ø5.0 Ø5.5 Ø6.0 Ø6.5 Ø7.5 Ø8.5 Ø9.5 Ø10.5

Colors



CHARSPINE2 MONOAXIAL REDUCTION SCREW

CHARSPINE system 2



CHARSPINE2 LOCKING SCREW

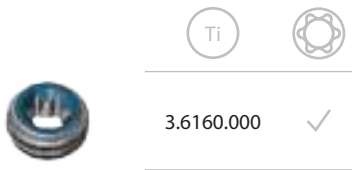

	Len	Ti		Len	Ti
4.0	25	3.6161.125	8.5	25	3.6168.125
	30	3.6161.130		30	3.6168.130
	35	3.6161.135		35	3.6168.135
	40	3.6161.140		40	3.6168.140
	45	3.6161.145		45	3.6168.145
4.5	25	3.6162.125	9.5	50	3.6168.150
	30	3.6162.130		55	3.6168.155
	35	3.6162.135		60	3.6168.160
	40	3.6162.140		65	3.6168.165
	45	3.6162.145		70	3.6168.170
5.0	25	3.6163.125	10.5	75	3.6168.175
	30	3.6163.130		80	3.6168.180
	35	3.6163.135		85	3.6168.185
	40	3.6163.140		90	3.6168.190
	45	3.6163.145		95	3.6168.195
5.5	50	3.6163.150	10.5	100	3.6168.001
	25	3.6164.125		25	3.6169.125
	30	3.6164.130		30	3.6169.130
	35	3.6164.135		35	3.6169.135
	40	3.6164.140		40	3.6169.140
6.0	45	3.6164.145	10.5	45	3.6169.145
	50	3.6164.150		50	3.6169.150
	55	3.6164.155		55	3.6169.155
	25	3.6165.125		60	3.6169.160
	30	3.6165.130		65	3.6169.165
6.5	35	3.6165.135	10.5	70	3.6169.170
	40	3.6165.140		75	3.6169.175
	45	3.6165.145		80	3.6169.180
	50	3.6165.150		85	3.6169.185
	55	3.6165.155		90	3.6169.190
7.0	60	3.6165.160	10.5	95	3.6169.195
	65	3.6165.165		100	3.6169.001
	25	3.6166.125		25	3.6149.125
	30	3.6166.130		30	3.6149.130
	35	3.6166.135		35	3.6149.135
7.5	40	3.6166.140	10.5	40	3.6149.140
	45	3.6166.145		45	3.6149.145
	50	3.6166.150		50	3.6149.150
	55	3.6166.155		55	3.6149.155
	60	3.6166.160		60	3.6149.160
8.0	65	3.6166.165	10.5	65	3.6149.165
	70	3.6166.170		70	3.6149.170
	75	3.6166.175		75	3.6149.175
	80	3.6166.180		80	3.6149.180
	85	3.6166.185		85	3.6149.185
8.5	90	3.6166.190	10.5	90	3.6149.190
	25	3.6167.125		95	3.6149.195
	30	3.6167.130		100	3.6149.001
	35	3.6167.135			
	40	3.6167.140			
9.0	45	3.6167.145			
	50	3.6167.150			
	55	3.6167.155			
	60	3.6167.160			
	65	3.6167.165			
9.5	70	3.6167.170			
	75	3.6167.175			
	80	3.6167.180			
	85	3.6167.185			
	90	3.6167.190			

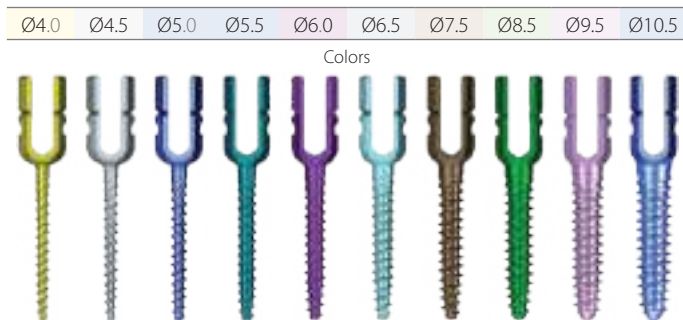

CHARSPINE2 POLYAXIAL SCREW

CHARSPINE system 2



CHARSPINE2 LOCKING SCREW

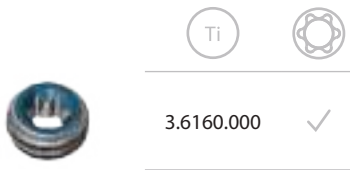

		Len	Ti			Len	Ti
4.0		25	3.6170.025	8.5		25	3.6530.025
		30	3.6170.030			30	3.6530.030
		35	3.6170.035			35	3.6530.035
		40	3.6170.040			40	3.6530.040
		45	3.6170.045			45	3.6530.045
4.5		25	3.6171.025		50	3.6530.050	
		30	3.6171.030		55	3.6530.055	
		35	3.6171.035		60	3.6530.060	
		40	3.6171.040		65	3.6530.065	
		45	3.6171.045		70	3.6530.070	
5.0		25	3.6172.025		75	3.6530.075	
		30	3.6172.030		80	3.6530.080	
		35	3.6172.035		85	3.6530.085	
		40	3.6172.040		90	3.6530.090	
		45	3.6172.045		95	3.6530.095	
5.5		50	3.6172.050		100	3.6530.100	
		25	3.6173.025	9.5		25	3.6531.025
		30	3.6173.030			30	3.6531.030
		35	3.6173.035			35	3.6531.035
		40	3.6173.040			40	3.6531.040
	45	3.6173.045			45	3.6531.045	
6.0		50	3.6173.050		50	3.6531.050	
		55	3.6173.055		55	3.6531.055	
		25	3.6174.025		60	3.6531.060	
		30	3.6174.030		65	3.6531.065	
		35	3.6174.035		70	3.6531.070	
6.5		40	3.6174.040		75	3.6531.075	
		45	3.6174.045		80	3.6531.080	
		50	3.6174.050		85	3.6531.085	
		55	3.6174.055		90	3.6531.090	
		60	3.6174.060		95	3.6531.095	
7.0		65	3.6174.065		100	3.6531.100	
		25	3.6175.025	10.5		25	3.6532.025
		30	3.6175.030			30	3.6532.030
		35	3.6175.035			35	3.6532.035
		40	3.6175.040			40	3.6532.040
	45	3.6175.045			45	3.6532.045	
7.5		50	3.6175.050		50	3.6532.050	
		55	3.6175.055		55	3.6532.055	
		60	3.6175.060		60	3.6532.060	
		65	3.6175.065		65	3.6532.065	
		25	3.6176.025		70	3.6532.070	
8.0		30	3.6176.030		75	3.6532.075	
		35	3.6176.035		80	3.6532.080	
		40	3.6176.040		85	3.6532.085	
		45	3.6176.045		90	3.6532.090	
		50	3.6176.050		95	3.6532.095	
8.5		55	3.6176.055		100	3.6532.100	
		60	3.6176.060				
		65	3.6176.065				
		70	3.6176.070				
		75	3.6176.075				
9.0		80	3.6176.080				
		85	3.6176.085				
		90	3.6176.090				

Ø4.0	Ø4.5	Ø5.0	Ø5.5	Ø6.0	Ø6.5	Ø7.5	Ø8.5	Ø9.5	Ø10.5
Colors									



CHARSPINE2 POLYAXIAL REDUCTION SCREW

CHARSPINE system 2

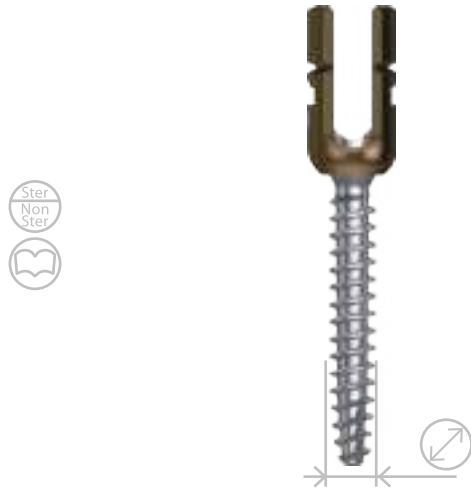

CHARSPINE2 LOCKING SCREW

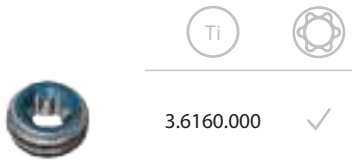

	Len	Ti		Len	Ti
4.0	25	3.6177.025	8.5	25	3.6533.025
	30	3.6177.030		30	3.6533.030
	35	3.6177.035		35	3.6533.035
	40	3.6177.040		40	3.6533.040
	45	3.6177.045		45	3.6533.045
4.5	25	3.6178.025	9.5	50	3.6533.050
	30	3.6178.030		55	3.6533.055
	35	3.6178.035		60	3.6533.060
	40	3.6178.040		65	3.6533.065
	45	3.6178.045		70	3.6533.070
5.0	25	3.6179.025	10.5	75	3.6533.075
	30	3.6179.030		80	3.6533.080
	35	3.6179.035		85	3.6533.085
	40	3.6179.040		90	3.6533.090
	45	3.6179.045		95	3.6533.095
5.5	50	3.6179.050	10.5	100	3.6533.100
	25	3.6180.025		25	3.6534.025
	30	3.6180.030		30	3.6534.030
	35	3.6180.035		35	3.6534.035
	40	3.6180.040		40	3.6534.040
6.0	45	3.6180.045	10.5	45	3.6534.045
	50	3.6180.050		50	3.6534.050
	55	3.6180.055		55	3.6534.055
	25	3.6181.025		60	3.6534.060
	30	3.6181.030		65	3.6534.065
6.5	35	3.6181.035	10.5	70	3.6534.070
	40	3.6181.040		75	3.6534.075
	45	3.6181.045		80	3.6534.080
	50	3.6181.050		85	3.6534.085
	55	3.6181.055		90	3.6534.090
7.0	60	3.6181.060	10.5	95	3.6534.095
	65	3.6181.065		100	3.6534.100
	25	3.6182.025		25	3.6535.025
	30	3.6182.030		30	3.6535.030
	35	3.6182.035		35	3.6535.035
7.5	40	3.6182.040	10.5	40	3.6535.040
	45	3.6182.045		45	3.6535.045
	50	3.6182.050		50	3.6535.050
	55	3.6182.055		55	3.6535.055
	60	3.6182.060		60	3.6535.060
8.0	65	3.6182.065	10.5	65	3.6535.065
	70	3.6182.070		70	3.6535.070
	75	3.6182.075		75	3.6535.075
	80	3.6182.080		80	3.6535.080
	85	3.6182.085		85	3.6535.085
8.5	90	3.6182.090	10.5	90	3.6535.090
	25	3.6183.025		95	3.6535.095
	30	3.6183.030		100	3.6535.100
	35	3.6183.035			
	40	3.6183.040			
9.0	45	3.6183.045			
	50	3.6183.050			
	55	3.6183.055			
	60	3.6183.060			
	65	3.6183.065			
9.5	70	3.6183.070			
	75	3.6183.075			
	80	3.6183.080			
	85	3.6183.085			
	90	3.6183.090			

Ø4.0 Ø4.5 Ø5.0 Ø5.5 Ø6.0 Ø6.5 Ø7.5 Ø8.5 Ø9.5 Ø10.5

Colors



CHARSPINE2 UNIPLANAR SCREW

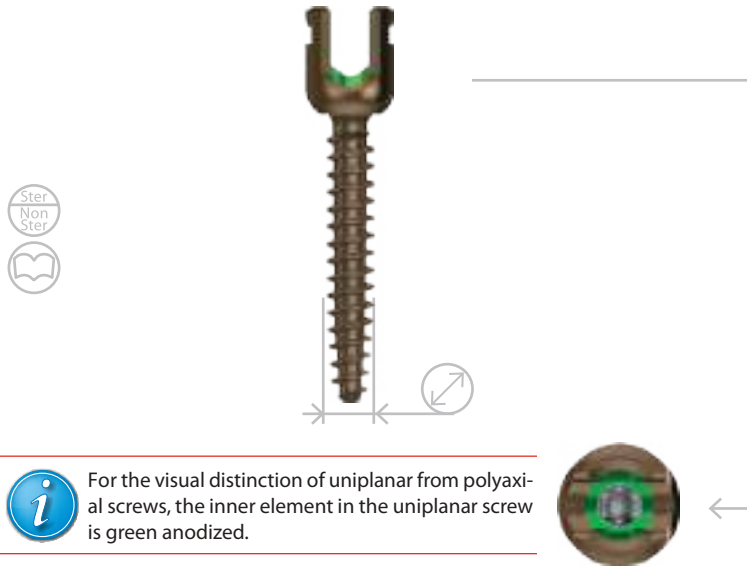

**i** For the visual distinction of uniplanar from polyaxial screws, the inner element in the uniplanar screw is green anodized.

CHARSPINE2 LOCKING SCREW

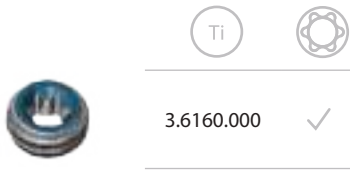

Ø4.0   Ø4.5   Ø5.0   Ø5.5   Ø6.0   Ø6.5   Ø7.5

Colors

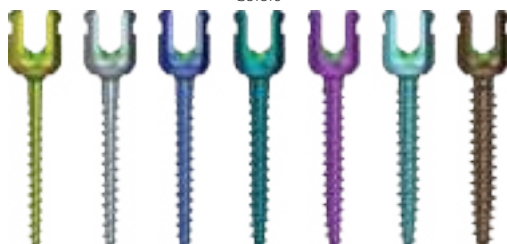

	Len	Ti
4.0	25	3.6184.025
	30	3.6184.030
	35	3.6184.035
	40	3.6184.040
	45	3.6184.045
4.5	25	3.6185.025
	30	3.6185.030
	35	3.6185.035
	40	3.6185.040
	45	3.6185.045
5.0	25	3.6186.025
	30	3.6186.030
	35	3.6186.035
	40	3.6186.040
	45	3.6186.045
5.5	50	3.6186.050
	25	3.6187.025
	30	3.6187.030
	35	3.6187.035
	40	3.6187.040
6.0	45	3.6187.045
	50	3.6187.050
	55	3.6187.055
	25	3.6188.025
	30	3.6188.030
6.5	35	3.6188.035
	40	3.6188.040
	45	3.6188.045
	50	3.6188.050
	55	3.6188.055
7.5	60	3.6188.060
	65	3.6188.065
	25	3.6189.025
	30	3.6189.030
	35	3.6189.035
8.0	40	3.6189.040
	45	3.6189.045
	50	3.6189.050
	55	3.6189.055
	60	3.6189.060
9.0	65	3.6189.065
	25	3.6190.025
	30	3.6190.030
	35	3.6190.035
	40	3.6190.040
10.0	45	3.6190.045
	50	3.6190.050
	55	3.6190.055
	60	3.6190.060
	65	3.6190.065
11.0	70	3.6190.070
	75	3.6190.075
	80	3.6190.080
	85	3.6190.085
	90	3.6190.090

CHARSPINE2 UNIPLANAR REDUCTION SCREW

CHARSPINE *system 2*

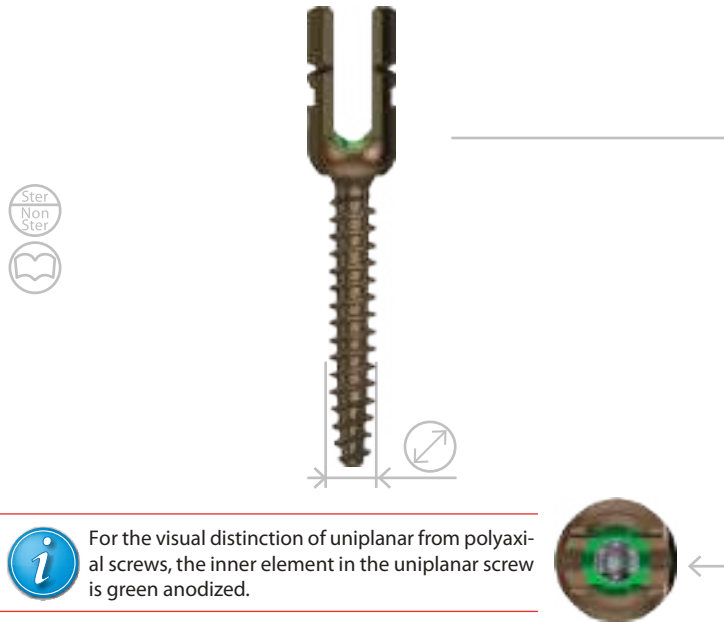

**i** For the visual distinction of uniplanar from polyaxial screws, the inner element in the uniplanar screw is green anodized.

CHARSPINE2 LOCKING SCREW

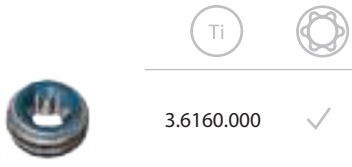

	Len	Ti
4.0	25	3.6191.025
	30	3.6191.030
	35	3.6191.035
	40	3.6191.040
	45	3.6191.045
4.5	25	3.6192.025
	30	3.6192.030
	35	3.6192.035
	40	3.6192.040
	45	3.6192.045
5.0	25	3.6193.025
	30	3.6193.030
	35	3.6193.035
	40	3.6193.040
	45	3.6193.045
5.5	50	3.6193.050
	25	3.6194.025
	30	3.6194.030
	35	3.6194.035
	40	3.6194.040
6.0	45	3.6194.045
	50	3.6194.050
	55	3.6194.055
	25	3.6195.025
	30	3.6195.030
6.5	35	3.6195.035
	40	3.6195.040
	45	3.6195.045
	50	3.6195.050
	55	3.6195.055
7.5	60	3.6195.060
	65	3.6195.065
	25	3.6196.025
	30	3.6196.030
	35	3.6196.035
	40	3.6196.040
	45	3.6196.045
	50	3.6196.050
	55	3.6196.055
	60	3.6196.060
	65	3.6196.065
	25	3.6197.025
	30	3.6197.030
	35	3.6197.035
	40	3.6197.040
	45	3.6197.045
	50	3.6197.050
	55	3.6197.055
	60	3.6197.060
	65	3.6197.065
	70	3.6197.070
	75	3.6197.075
	80	3.6197.080
	85	3.6197.085
	90	3.6197.090

CHARSPINE2 POLYAXIAL SCREW FOR PELVIS

CHARSPINE *system 2*

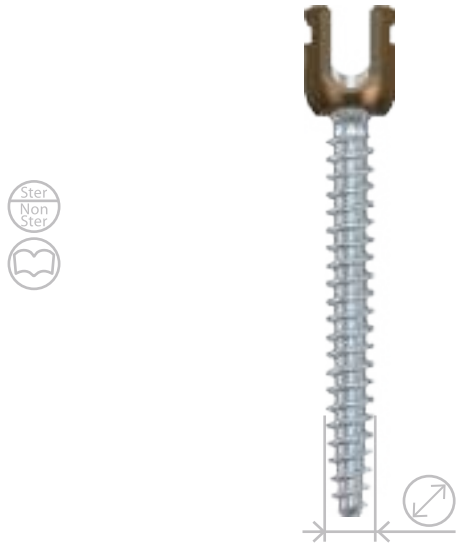

	Len	Ti
6.5	25	3.6514.025
	30	3.6514.030
	35	3.6514.035
	40	3.6514.040
	45	3.6514.045
	50	3.6514.050
	55	3.6514.055
	60	3.6514.060
	65	3.6514.065
	70	3.6514.070
	75	3.6514.075
	80	3.6514.080
	85	3.6514.085
	90	3.6514.090
	7.5	25
30		3.6515.030
35		3.6515.035
40		3.6515.040
45		3.6515.045
50		3.6515.050
55		3.6515.055
60		3.6515.060
65		3.6515.065
70		3.6515.070
75		3.6515.075
80		3.6515.080
85		3.6515.085
90		3.6515.090

CHARSPINE2 LOCKING SCREW

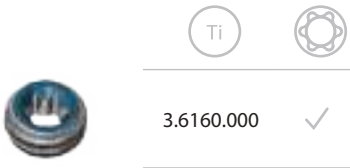

Ø6.5    Ø7.5  
Colors



CHARSPINE2 POLYAXIAL SCREW FOR PELVIS

CHARSPINE *system 2*

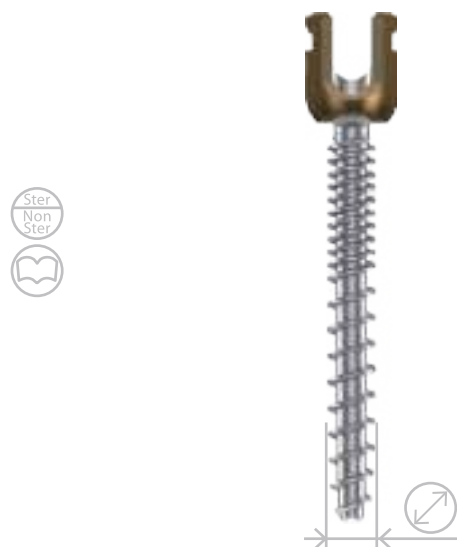

CHARSPINE2 LOCKING SCREW

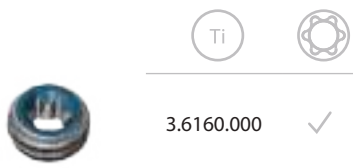

	Len	Ti
6.5	25	3.6514.525
	30	3.6514.530
	35	3.6514.535
	40	3.6514.540
	45	3.6514.545
	50	3.6514.550
	55	3.6514.555
	60	3.6514.560
	65	3.6514.565
	70	3.6514.570
	75	3.6514.575
	80	3.6514.580
	85	3.6514.585
	90	3.6514.590
	7.5	25
30		3.6515.530
35		3.6515.535
40		3.6515.540
45		3.6515.545
50		3.6515.550
55		3.6515.555
60		3.6515.560
65		3.6515.565
70		3.6515.570
75		3.6515.575
80		3.6515.580
85		3.6515.585
90		3.6515.590



To include taps for double-threaded screws to the standard instrument set for stabilizing the spine - **CHARSPINE2** [15.0907.001] - please contact your local representative or **ChM** Sales Department.





CHARSPINE2 MONOAXIAL SCREW

CHARSPINE system 2



	Len	Ti		Len	Ti
4.0	25	3.6150.525	8.5	25	3.6157.525
	30	3.6150.530		30	3.6157.530
	35	3.6150.535		35	3.6157.535
	40	3.6150.540		40	3.6157.540
	45	3.6150.545		45	3.6157.545
4.5	25	3.6151.525	9.5	50	3.6157.550
	30	3.6151.530		55	3.6157.555
	35	3.6151.535		60	3.6157.560
	40	3.6151.540		65	3.6157.565
	45	3.6151.545		70	3.6157.570
5.0	25	3.6152.525	10.5	75	3.6157.575
	30	3.6152.530		80	3.6157.580
	35	3.6152.535		85	3.6157.585
	40	3.6152.540		90	3.6157.590
	45	3.6152.545		95	3.6157.595
5.5	50	3.6152.550	7.5	100	3.6157.601
	25	3.6153.525		25	3.6158.525
	30	3.6153.530		30	3.6158.530
	35	3.6153.535		35	3.6158.535
	40	3.6153.540		40	3.6158.540
6.0	45	3.6153.545	6.5	45	3.6158.545
	50	3.6153.550		50	3.6158.550
	55	3.6153.555		55	3.6158.555
	25	3.6154.525		60	3.6158.560
	30	3.6154.530		65	3.6158.565
6.5	35	3.6154.535	6.0	70	3.6158.570
	40	3.6154.540		75	3.6158.575
	45	3.6154.545		80	3.6158.580
	50	3.6154.550		85	3.6158.585
	55	3.6154.555		90	3.6158.590
7.0	60	3.6154.560	5.5	95	3.6158.595
	65	3.6154.565		100	3.6158.601
	25	3.6155.525		25	3.6159.525
	30	3.6155.530		30	3.6159.530
	35	3.6155.535		35	3.6159.535
7.5	40	3.6155.540	5.0	40	3.6159.540
	45	3.6155.545		45	3.6159.545
	50	3.6155.550		50	3.6159.550
	55	3.6155.555		55	3.6159.555
	60	3.6155.560		60	3.6159.560
8.0	65	3.6155.565	4.5	65	3.6159.565
	25	3.6156.525		70	3.6159.570
	30	3.6156.530		75	3.6159.575
	35	3.6156.535		80	3.6159.580
	40	3.6156.540		85	3.6159.585
8.5	45	3.6156.545	4.0	90	3.6159.590
	50	3.6156.550		95	3.6159.595
	55	3.6156.555		100	3.6159.601
	60	3.6156.560			
	65	3.6156.565			
9.0	70	3.6156.570			
	75	3.6156.575			
	80	3.6156.580			
	85	3.6156.585			
	90	3.6156.590			

CHARSPINE2 LOCKING SCREW

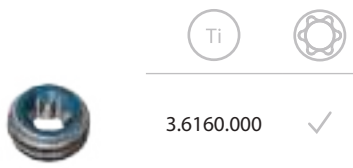

To include taps for double-threaded screws to the standard instrument set for stabilizing the spine - CHARSPINE2 [15.0907.001] - please contact your local representative or ChM Sales Department.

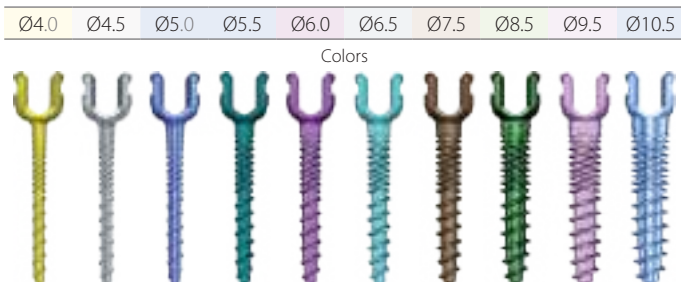

CHARSPINE2 MONOAXIAL REDUCTION SCREW

CHARSPINE system 2



CHARSPINE2 LOCKING SCREW

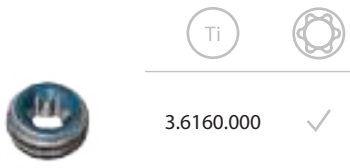

To include taps for double-threaded screws to the standard instrument set for stabilizing the spine - CHARSPINE2 [15.0907.001] - please contact your local representative or ChM Sales Department.

Ø4.0   Ø4.5   Ø5.0   Ø5.5   Ø6.0   Ø6.5   Ø7.5   Ø8.5   Ø9.5   Ø10.5

Colors

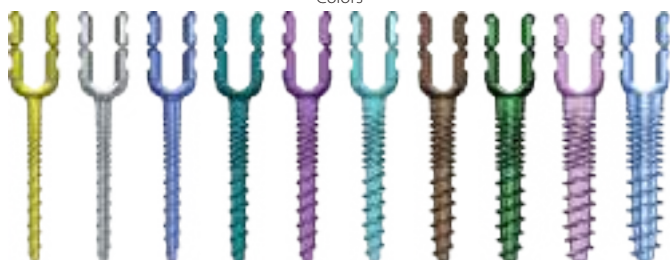

Len	Ti	Len	Ti		
4.0	25	3.6161.525	8.5	25	3.6168.525
	30	3.6161.530		30	3.6168.530
	35	3.6161.535		35	3.6168.535
	40	3.6161.540		40	3.6168.540
	45	3.6161.545		45	3.6168.545
4.5	25	3.6162.525	9.5	50	3.6168.550
	30	3.6162.530		55	3.6168.555
	35	3.6162.535		60	3.6168.560
	40	3.6162.540		65	3.6168.565
	45	3.6162.545		70	3.6168.570
5.0	25	3.6163.525	10.5	75	3.6168.575
	30	3.6163.530		80	3.6168.580
	35	3.6163.535		85	3.6168.585
	40	3.6163.540		90	3.6168.590
	45	3.6163.545		95	3.6168.595
5.5	50	3.6163.550	10.5	100	3.6168.601
	25	3.6164.525		25	3.6169.525
	30	3.6164.530		30	3.6169.530
	35	3.6164.535		35	3.6169.535
	40	3.6164.540		40	3.6169.540
6.0	45	3.6164.545	10.5	45	3.6169.545
	50	3.6164.550		50	3.6169.550
	55	3.6164.555		55	3.6169.555
	25	3.6165.525		60	3.6169.560
	30	3.6165.530		65	3.6169.565
6.5	35	3.6165.535	10.5	70	3.6169.570
	40	3.6165.540		75	3.6169.575
	45	3.6165.545		80	3.6169.580
	50	3.6165.550		85	3.6169.585
	55	3.6165.555		90	3.6169.590
7.5	60	3.6165.560	10.5	95	3.6169.595
	65	3.6165.565		100	3.6169.601
	25	3.6166.525		25	3.6149.525
	30	3.6166.530		30	3.6149.530
	35	3.6166.535		35	3.6149.535
7.5	40	3.6166.540	10.5	40	3.6149.540
	45	3.6166.545		45	3.6149.545
	50	3.6166.550		50	3.6149.550
	55	3.6166.555		55	3.6149.555
	60	3.6166.560		60	3.6149.560
7.5	65	3.6166.565	10.5	65	3.6149.565
	25	3.6167.525		70	3.6149.570
	30	3.6167.530		75	3.6149.575
	35	3.6167.535		80	3.6149.580
	40	3.6167.540		85	3.6149.585
7.5	45	3.6167.545	10.5	90	3.6149.590
	50	3.6167.550		95	3.6149.595
	55	3.6167.555		100	3.6149.601
	60	3.6167.560			
	65	3.6167.565			
7.5	70	3.6167.570			
	75	3.6167.575			
	80	3.6167.580			
	85	3.6167.585			
	90	3.6167.590			

CHARSPINE2 POLYAXIAL SCREW



	Len	Ti
4.0	25	3.6170.525
	30	3.6170.530
	35	3.6170.535
	40	3.6170.540
	45	3.6170.545
	50	3.6170.550
4.5	25	3.6171.525
	30	3.6171.530
	35	3.6171.535
	40	3.6171.540
	45	3.6171.545
	50	3.6171.550
5.0	25	3.6172.525
	30	3.6172.530
	35	3.6172.535
	40	3.6172.540
	45	3.6172.545
	50	3.6172.550
5.5	25	3.6173.525
	30	3.6173.530
	35	3.6173.535
	40	3.6173.540
	45	3.6173.545
	50	3.6173.550
6.0	25	3.6174.525
	30	3.6174.530
	35	3.6174.535
	40	3.6174.540
	45	3.6174.545
	50	3.6174.550
6.5	25	3.6175.525
	30	3.6175.530
	35	3.6175.535
	40	3.6175.540
	45	3.6175.545
	50	3.6175.550
7.0	25	3.6176.525
	30	3.6176.530
	35	3.6176.535
	40	3.6176.540
	45	3.6176.545
	50	3.6176.550
7.5	55	3.6176.555
	60	3.6176.560
	65	3.6176.565
	70	3.6176.570
	75	3.6176.575
	80	3.6176.580

	Len	Ti
8.5	25	3.6530.525
	30	3.6530.530
	35	3.6530.535
	40	3.6530.540
	45	3.6530.545
	50	3.6530.550
9.5	55	3.6530.555
	60	3.6530.560
	65	3.6530.565
	70	3.6530.570
	75	3.6530.575
	80	3.6530.580
10.5	85	3.6530.585
	90	3.6530.590
	95	3.6530.595
	100	3.6530.600
	25	3.6531.525
	30	3.6531.530
9.5	35	3.6531.535
	40	3.6531.540
	45	3.6531.545
	50	3.6531.550
	55	3.6531.555
	60	3.6531.560
9.5	65	3.6531.565
	70	3.6531.570
	75	3.6531.575
	80	3.6531.580
	85	3.6531.585
	90	3.6531.590
10.5	95	3.6531.595
	100	3.6531.600
	25	3.6532.525
	30	3.6532.530
	35	3.6532.535
	40	3.6532.540
10.5	45	3.6532.545
	50	3.6532.550
	55	3.6532.555
	60	3.6532.560
	65	3.6532.565
	70	3.6532.570
10.5	75	3.6532.575
	80	3.6532.580
	85	3.6532.585
	90	3.6532.590
	95	3.6532.595
	100	3.6532.600

CHARSPINE2 LOCKING SCREW

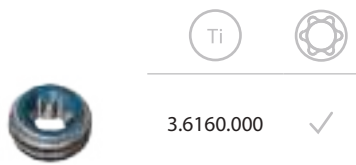

To include taps for double-threaded screws to the standard instrument set for stabilizing the spine - CHARSPINE2 [15.0907.001] - please contact your local representative or ChM Sales Department.

Ø4.0 Ø4.5 Ø5.0 Ø5.5 Ø6.0 Ø6.5 Ø7.5 Ø8.5 Ø9.5 Ø10.5

Colors

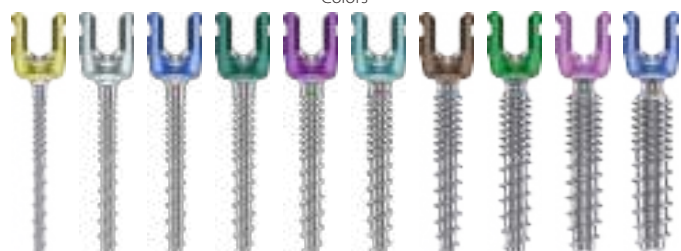

CHARSPINE2 POLYAXIAL REDUCTION SCREW

CHARSPINE system 2

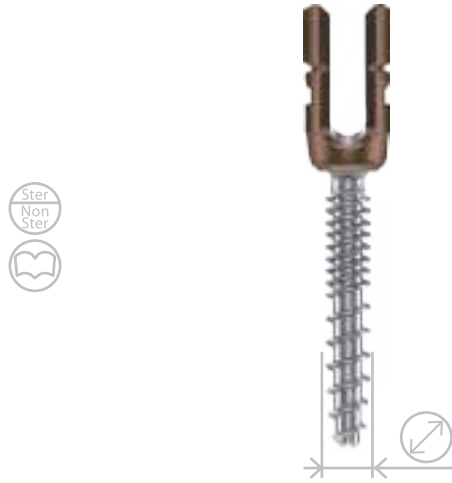

CHARSPINE2 LOCKING SCREW

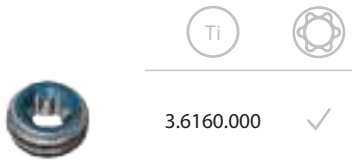

To include taps for double-threaded screws to the standard instrument set for stabilizing the spine - **CHARSPINE2** [15.0907.001] - please contact your local representative or ChM Sales Department.

Ø4.0   Ø4.5   Ø5.0   Ø5.5   Ø6.0   Ø6.5   Ø7.5   Ø8.5   Ø9.5   Ø10.5

Colors



		Len	Ti			Len	Ti
4.0		25	3.6177.525		8.5	25	3.6533.525
		30	3.6177.530			30	3.6533.530
		35	3.6177.535			35	3.6533.535
		40	3.6177.540			40	3.6533.540
		45	3.6177.545			45	3.6533.545
4.5		25	3.6178.525		9.5	50	3.6533.550
		30	3.6178.530			55	3.6533.555
		35	3.6178.535			60	3.6533.560
		40	3.6178.540			65	3.6533.565
		45	3.6178.545			70	3.6533.570
5.0		20	3.6179.520		10.5	75	3.6533.575
		25	3.6179.525			80	3.6533.580
		30	3.6179.530			85	3.6533.585
		35	3.6179.535			90	3.6533.590
		40	3.6179.540			95	3.6533.595
5.5		45	3.6179.545		10.5	100	3.6533.600
		50	3.6179.550			25	3.6534.525
		25	3.6180.525			30	3.6534.530
		30	3.6180.530			35	3.6534.535
		35	3.6180.535			40	3.6534.540
6.0		40	3.6180.540		10.5	45	3.6534.545
		45	3.6180.545			50	3.6534.550
		50	3.6180.550			55	3.6534.555
		55	3.6180.555			60	3.6534.560
		25	3.6181.525			65	3.6534.565
6.5		30	3.6181.530		10.5	70	3.6534.570
		35	3.6181.535			75	3.6534.575
		40	3.6181.540			80	3.6534.580
		45	3.6181.545			85	3.6534.585
		50	3.6181.550			90	3.6534.590
7.0		55	3.6181.555		10.5	95	3.6534.595
		60	3.6181.560			100	3.6534.600
		65	3.6181.565			25	3.6535.525
		25	3.6182.525			30	3.6535.530
		30	3.6182.530			35	3.6535.535
7.5		35	3.6182.535		10.5	40	3.6535.540
		40	3.6182.540			45	3.6535.545
		45	3.6182.545			50	3.6535.550
		50	3.6182.550			55	3.6535.555
		55	3.6182.555			60	3.6535.560
8.0		60	3.6182.560		10.5	65	3.6535.565
		65	3.6182.565			70	3.6535.570
		25	3.6183.525			75	3.6535.575
		30	3.6183.530			80	3.6535.580
		35	3.6183.535			85	3.6535.585
8.5		40	3.6183.540		10.5	90	3.6535.590
		45	3.6183.545			95	3.6535.595
		50	3.6183.550			100	3.6535.600
		55	3.6183.555				
		60	3.6183.560				
9.0		65	3.6183.565				
		70	3.6183.570				
		75	3.6183.575				
		80	3.6183.580				
		85	3.6183.585				
9.5		90	3.6183.590				

ROD 6

CHARSPINE *system 2*

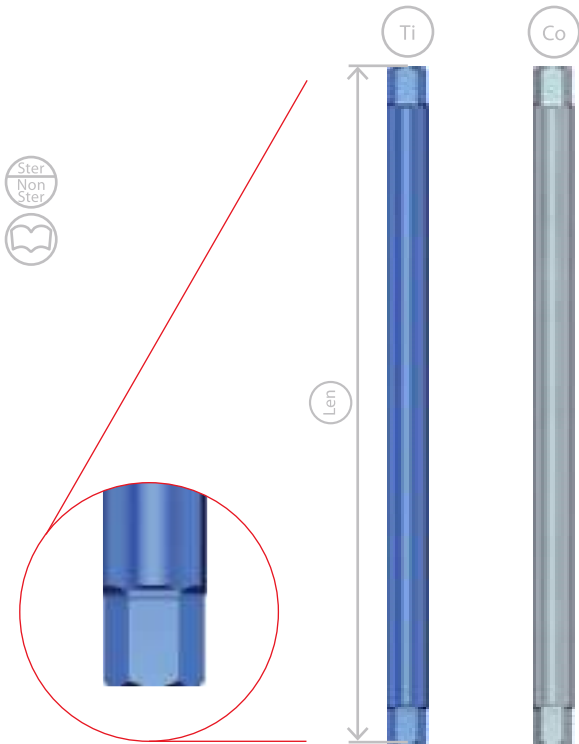

Len	Ti	Co
40	3.3246.040	4.3980.040
50	3.3246.050	4.3980.050
60	3.3246.060	4.3980.060
70	3.3246.070	4.3980.070
80	3.3246.080	4.3980.080
90	3.3246.090	4.3980.090
100	3.3246.100	4.3980.100
120	3.3246.120	4.3980.120
140	3.3246.140	4.3980.140
160	3.3246.160	4.3980.160
180	3.3246.180	4.3980.180
200	3.3246.200	4.3980.200
220	3.3246.220	4.3980.220
260	3.3246.260	4.3980.260
300	3.3246.300	4.3980.300
360	3.3246.360	4.3980.360
400	3.3246.400	4.3980.400
460	3.3246.460	4.3980.460
500	3.3246.500	4.3980.500

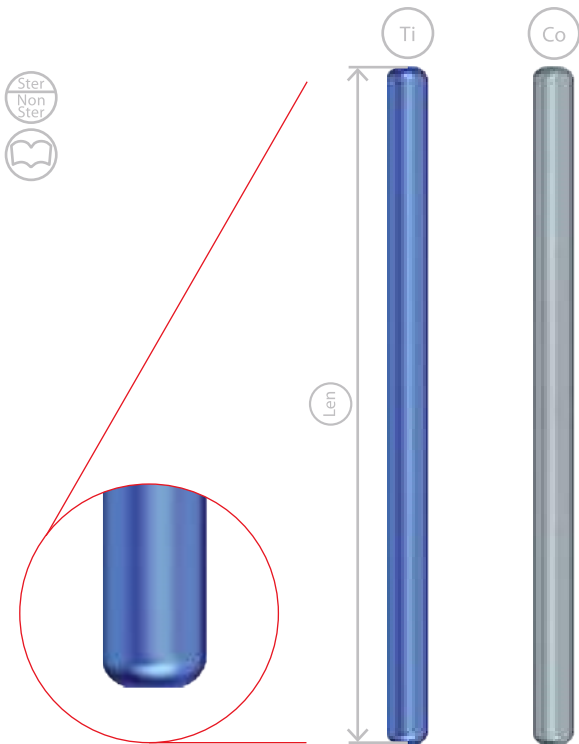

Len	Ti	Co
40	3.3248.040	4.3249.040
50	3.3248.050	4.3249.050
60	3.3248.060	4.3249.060
70	3.3248.070	4.3249.070
80	3.3248.080	4.3249.080
90	3.3248.090	4.3249.090
100	3.3248.100	4.3249.100
120	3.3248.120	4.3249.120
140	3.3248.140	4.3249.140
160	3.3248.160	4.3249.160
180	3.3248.180	4.3249.180
200	3.3248.200	4.3249.200

CURVED ROD 6

CHARSPINE system 2

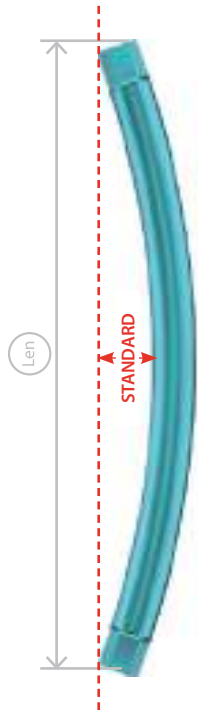

Len	Ti
35	3.6280.035
40	3.6280.040
45	3.6280.045
50	3.6280.050
55	3.6280.055
60	3.6280.060
65	3.6280.065
70	3.6280.070
75	3.6280.075
80	3.6280.080
85	3.6280.085
90	3.6280.090
95	3.6280.095
100	3.6280.100
110	3.6280.110
120	3.6280.120
130	3.6280.130
140	3.6280.140
150	3.6280.150
160	3.6280.160
170	3.6280.170
180	3.6280.180
190	3.6280.190
200	3.6280.200

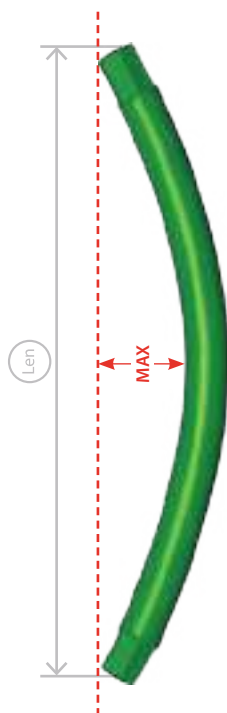

Len	Ti
35	3.6295.035
40	3.6295.040
45	3.6295.045
50	3.6295.050
55	3.6295.055
60	3.6295.060
65	3.6295.065
70	3.6295.070
75	3.6295.075
80	3.6295.080
85	3.6295.085

ANGLED ROD 6

**CHARSPINE** *system 2*

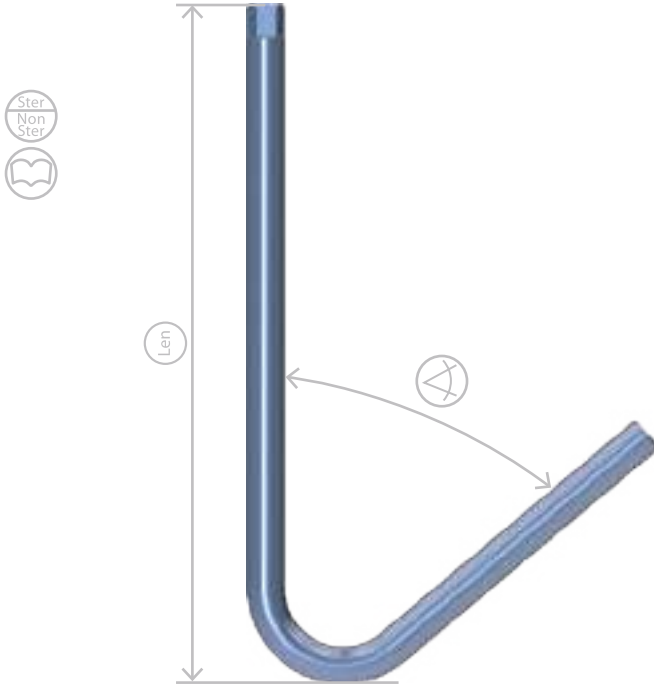

	Len	Ti
50°	150	3.3981.155
	200	3.3981.205
	250	3.3981.255
	300	3.3981.305
	350	3.3981.355
60°	450	3.3981.455
	150	3.3981.156
	200	3.3981.206
	250	3.3981.256
	300	3.3981.306
70°	350	3.3981.356
	450	3.3981.456
	150	3.3981.157
	200	3.3981.207
	250	3.3981.257
70°	300	3.3981.307
	350	3.3981.357
	450	3.3981.456



	Len	Co
50°	150	4.3981.155
	200	4.3981.205
	250	4.3981.255
	300	4.3981.305
	350	4.3981.355
60°	450	4.3981.455
	150	4.3981.156
	200	4.3981.206
	250	4.3981.256
	300	4.3981.306
70°	350	4.3981.356
	450	4.3981.456
	150	4.3981.157
	200	4.3981.207
	250	4.3981.257
70°	300	4.3981.307
	350	4.3981.357
	450	4.3981.456

## CROSSWISE CONNECTOR SOLID (SET)

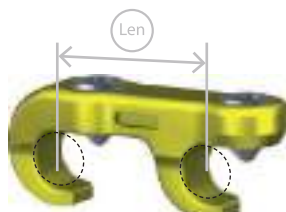
CHARSPINE *system 2*

Len	Ti
14	3.6290.014
15	3.6290.015
16	3.6290.016
17	3.6290.017
18	3.6290.018
19	3.6290.019
20	3.6290.020
21	3.6290.021
22	3.6290.022
23	3.6290.023
24	3.6290.024
25	3.6290.025
26	3.6290.026
27	3.6290.027
28	3.6290.028
29	3.6290.029
30	3.6290.030



CROSSWISE CONNECTOR REGULATED (SET)

CHARSPINE system 2

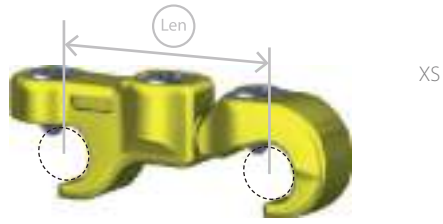

XS

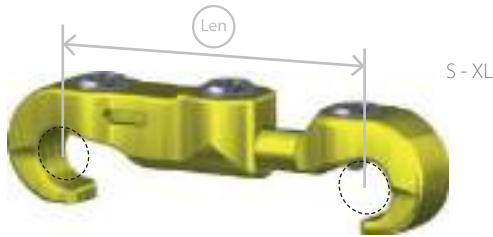

S - XL

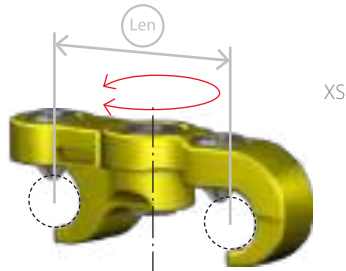

XS

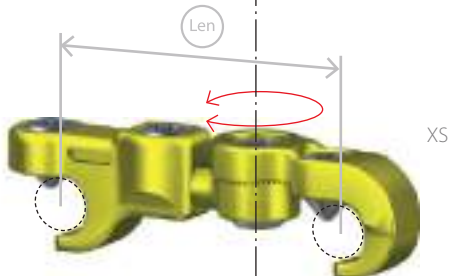

XS

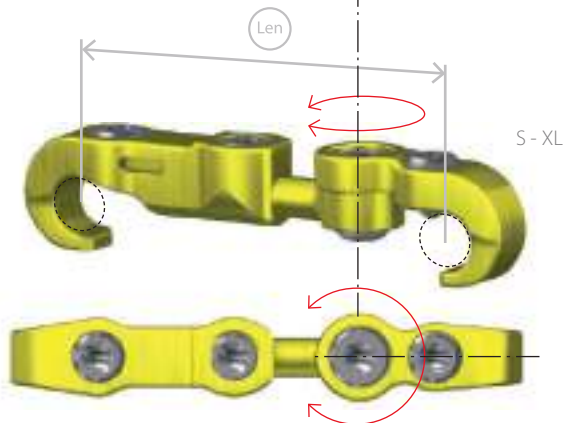

S - XL

	Len	Ti
XS	26-30.5	3.3979.026

	Len	Ti
S	30.5-33	3.3979.030
M	33-38.5	3.3979.033
L	38.5-49	3.3979.038
XL	49-71	3.3979.049

	Len	Ti
XS	22	3.6296.022
	24	3.6296.024
	26	3.6296.026
	28	3.6296.028
	30	3.6296.030
	32	3.6296.032
	34	3.6296.034

	Len	Ti
XS	33-37.5	3.3972.033

	Len	Ti
S	37.5-40	3.3972.037
M	40-45.5	3.3972.040
L	45.5-56.5	3.3972.045
XL	56.5-78	3.3972.056
XXL	78-99	3.3972.078

AXIAL CONNECTOR (SET)

CHARSPINE system 2



$\begin{matrix} \circlearrowleft \\ d \end{matrix}$	$\begin{matrix} \circlearrowleft \\ D \end{matrix}$	Ti
5	5	3.3970.855
6	5	3.3970.865
6	6	3.3970.866

PARALLEL CONNECTOR (SET)

CHARSPINE system 2

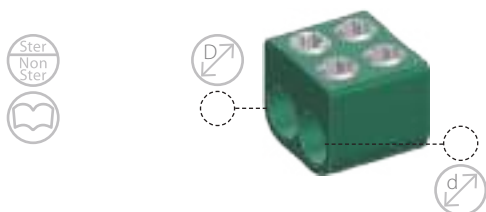

$\begin{matrix} \circlearrowleft \\ d \end{matrix}$	$\begin{matrix} \circlearrowleft \\ D \end{matrix}$	Ti
5	5	3.3970.955
6	5	3.3970.965
6	6	3.3970.966

PARALLEL CONNECTOR (SET)

CHARSPINE system 2

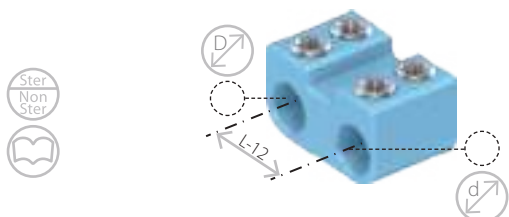

$\begin{matrix} \circlearrowleft \\ d \end{matrix}$	$\begin{matrix} \circlearrowleft \\ D \end{matrix}$	Ti
6	6	3.6294.012

ANGULAR CONNECTOR

CHARSPINE system 2

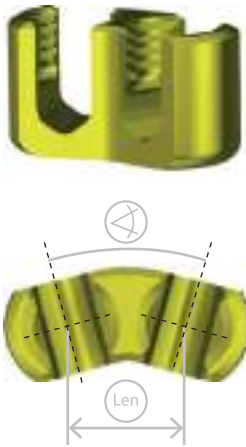

	Len	Ti
0°	12	3.6284.012
	16	3.6284.016
10°	12	3.6285.012
	16	3.6285.016
30°	12	3.6286.012
	16	3.6286.016

CHARSPINE2 LOCKING SCREW



3.6160.000 ✓

LATERAL CONNECTOR

CHARSPINE system 2

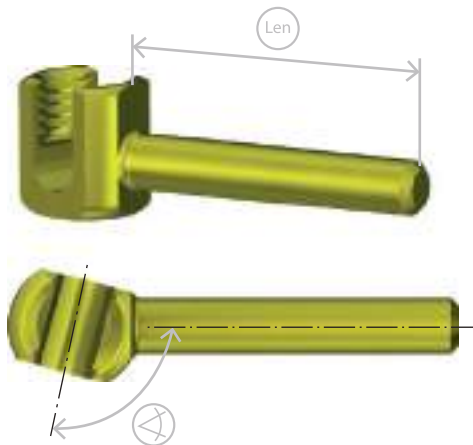

	Len	Ti
90°	15	3.6281.015
	20	3.6281.020
	25	3.6281.025
	30	3.6281.030
	35	3.6281.035
75°	15	3.6282.015
	20	3.6282.020
	25	3.6282.025
	30	3.6282.030
	35	3.6282.035
105°	15	3.6283.015
	20	3.6283.020
	25	3.6283.025
	30	3.6283.030
	35	3.6283.035

CHARSPINE2 LOCKING SCREW



3.6160.000 ✓

CLAMP CROSSWISE CONNECTOR (SET)

CHARSPINE system 2



Ti

3.6287.000

LATERAL CONNECTOR

CHARSPINE system 2



Len

Ti

Len	Ti
35	3.6289.035
40	3.6289.040
45	3.6289.045
50	3.6289.050
55	3.6289.055
60	3.6289.060
65	3.6289.065
70	3.6289.070
80	3.6289.080
90	3.6289.090
100	3.6289.100

SINGLE-HOLE STAPLE

CHARSPINE system 2



Ti

3.6291.000

DOUBLE-HOLE STAPLE ROSTRAL

CHARSPINE system 2

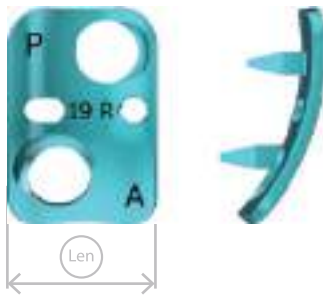

Len

Ti

19	3.6292.016
21	3.6292.021
23	3.6292.023
25	3.6292.025
27	3.6292.027

DOUBLE-HOLE STAPLE CAUDAL

CHARSPINE system 2

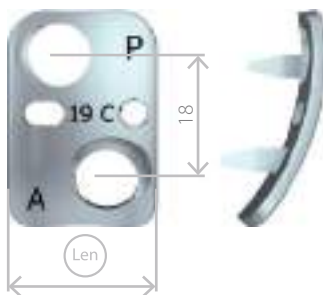











Len

Ti

19	3.6293.016
21	3.6293.021
23	3.6293.023
25	3.6293.025
27	3.6293.027

SPINAL HOOKS



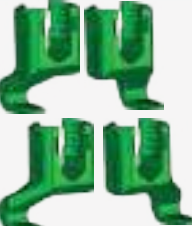

CHARSPINE *system 2*

Small	Standard	Large
Laminar hook		
 <p>3.6266.001</p>	 <p>3.6266.002</p>	 <p>3.6266.003</p>
Laminar hook, narrow blade		
 <p>3.6267.001</p>	 <p>3.6267.002</p>	 <p>3.6267.003</p>
Laminar hook, extended body		
<p>3.6268.001*</p>	 <p>3.6268.002</p>	<p>3.6268.003*</p>
Laminar hook, offset		
<p>3.6269.001 – right *</p> <p>3.6269.101 – left *</p>	 <p>3.6269.002 – right</p> <p>3.6269.102 – left</p>	<p>3.6269.003 – right *</p> <p>3.6269.103 – left *</p>
Laminar hook, angled blade		
<p>3.6270.001*</p>	 <p>3.6270.002</p>	<p>3.6270.003*</p>
Thoracic laminar hook		
	 <p>3.6271.002</p>	
Thoracic laminar hook, narrow blade		
	 <p>3.6272.002</p>	
Thoracic laminar hook, offset		
	 <p>3.6273.002 – Small offset, right;</p> <p>3.6273.102 – Small offset, left;</p> <p>3.6274.002 – Large offset, right;</p> <p>3.6274.102 – Large offset, left;</p>	

\* available as additional item

## SPINAL HOOKS

CHARSPINE *system 2*

Small	Standard	Large
Pedicule hook		
 3.6275.001	 3.6275.002	 3.6275.003*
Transverse process hook		
3.6276.001 – right* 3.6276.101 – left*	 3.6276.002 – right 3.6276.102 – left	3.6276.003 – right* 3.6276.103 – left*

\* available as additional item



The palettes for implants presented below are not offered as sets (*they do not include implants*).

40.8064.000  
PALETTE FOR CHARSPINE2 IMPLANTS - SCREWS



Screw diameter	Size L	No. of sockets
4.5	25	2
	30	2
	35	2
	40	2
	45	2
	50	2
5.0	35	2
	40	2
	45	2
	50	2
	55	2
	60	2
5.5	30	8
	35	8
	40	8
	45	8
	50	8
	55	8
6.0	35	8
	40	8
	45	8
	50	8
	55	8
	60	8
6.5	35	6
	40	6
	45	6
	50	6
	55	6
	60	6
7.5	35	6
	40	6
	45	6
	50	6
	55	6
	60	6
8.5	50	2
	55	2
	60	2
	70	2
	80	2
	90	2
9.5	50	2
	55	2
	60	2
	70	2
	80	2
	90	2
5.5	30	4
	35	4
	40	4
	45	4
	50	4
	55	4
6.0	35	4
	40	4
	45	4
	50	4
	55	4
	60	4
6.5	35	6
	40	6
	45	6
	50	6
	55	6
	60	6
7.5	35	6
	40	6
	45	6
	50	6
	55	6
	60	6

Monoaxial screws

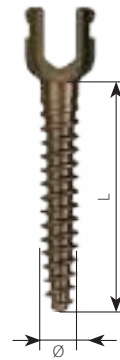

Polyaxial screws

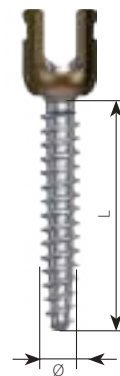



40.8119.000  
PALETTE SMALL FOR CHARSPINE2 IMPLANTS - SCREWS



Monoaxial, polyaxial and uniplanar screws

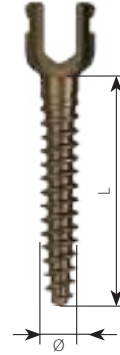

Screw diameter	Size L	No. of sockets
5.0	30	6
	35	6
	40	6
	45	6
	50	5
5.5	30	6
	35	6
	40	6
	45	6
	50	5
6.0	35	6
	40	6
	45	6
	50	6
	55	6
6.5	60	5
	35	6
	40	6
	45	6
	50	6
	55	6
	60	5

MODULAR PALETTE FOR CHARSPINE2 IMPLANTS - CONNECTORS 1 (STANDARD CONFIGURATION)



40.8065.000  
Palette for CHARSPINE2 implants - Connectors 1



40.8078.000  
Exchangeable module 1



40.8080.000  
Exchangeable module 3

40.8065.000  
 Palette for CHARSPINE2 implants - Connectors 1

Implant type

Size

No. of sockets



Rods

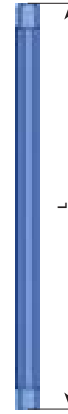

L-40	2
L-50	2
L-60	2
L-70	2
L-80	2
L-90	2
L-100	2
L-120	4
L-140	2
L-160	2
L-180	2
L-200	2
L-220	4
L-260	4
L-300	2
L-360	2
L-460	2

Rod connectors

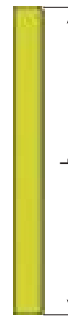

L-60	2
L-80	2
L-100	2

Locking screws



-	28
---	----



Axial connector



6/6	1
-----	---

Parallel connector



6/6	1
-----	---

Clamp crosswise connector



-	4
---	---

EXCHANGEABLE MODULES – IMPLANT SOCKETS CONFIGURATION

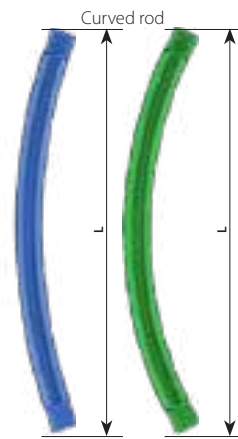
40.8078.000 Exchangeable module 1	Implant type	Size	No. of sockets
		L-35	1
		L-40	1
		L-45	1
		L-50	1
		L-55	1
		L-60	1
		L-65	1
		L-70	1
		L-75	1
		L-80	1
L-85	1		

40.6795.000 Exchangeable module 5	Implant type	Size	No. of sockets
		L-90	1
		L-95	1
		L-100	1
		L-110	1
		L-120	1
		L-130	1
		L-140	1
		L-150	1
		L-160	1

40.8080.000 Exchangeable module 3	Implant type	Size	No. of sockets
	Crosswise connector solid 	L-14	1
		L-15	1
		L-16	1
		L-17	1
		L-18	1
		L-19	1
	L-20	1	
	Crosswise connector regulated (monoaxial) 	XS	1
		S	1
		M	1
		L	1
	Lateral connector (polyaxial) 	XS	1
		S	1
		M	1
L		1	
	XL	1	

MODULAR PALETTE FOR CHARSPINE2 IMPLANTS - CONNECTORS 2 (STANDARD CONFIGURATION)



40.8066.000  
Palette for **CHARSPINE2** implants -  
Connectors 2



40.8081.000  
Exchangeable module 4



40.8079.000  
Exchangeable module 2

EXCHANGEABLE MODULES – IMPLANT SOCKETS CONFIGURATION

40.8081.000  
Exchangeable module 4



Implant type	Size	No. of sockets
Angular connector	L-12	1
	L-16	1
	10° L-12	1
	10° L-16	1
	30° L-12	1
	30° L-16	1
Lateral connector	90° L-15	1
	90° L-20	1
	90° L-25	1
	90° L-30	1
	75° L-15	1
	75° L-20	1
	75° L-25	1
	75° L-30	1
	105° L-15	1
	105° L-20	1
105° L-25	1	
105° L-30	1	

Angular connector



Lateral connector



40.8079.000  
Exchangeable module 2



Implant type	Size	No. of sockets
Single-hole staple	-	8
Double-hole staple rostral	L-19	2
	L-21	1
	L-23	1
	L-25	1
	L-27	1
Double-hole staple caudal	L-19	2
	L-21	1
	L-23	1
	L-25	1
	L-27	1

Single-hole staple



Double-hole staple rostral

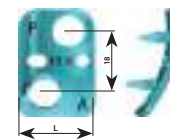

Double-hole staple caudal

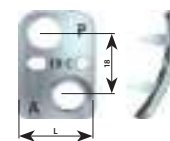











It is possible to change the configuration of modules included into palettes according to an individual order.











40.8077.000

Palette for CHARSPINE2 implants - Hooks



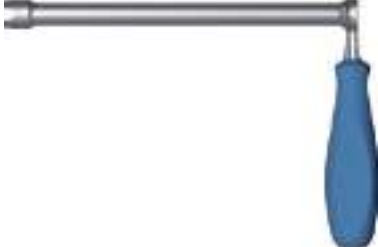















	Implant type	Variant	No. of sockets
	Laminar hook	Small	6
		Standard	6
		Large	6
	Laminar hook, narrow blade	Small	6
		Standard	6
		Large	6
	Laminar hook, extended body	-	2
	Laminar hook, offset	Right	2
		Left	2
	Laminar hook, angled blade	-	2
	Thoracic laminar hook	-	3
	Thoracic laminar hook, narrow blade	-	3
	Thoracic laminar hook, narrow blade	Right	3
		Left	3
	Thoracic laminar hook, large offset	Right	3
		Left	3
	Pedicule hook	Small	2
		Standard	2
	Transverse process hook	Right	3
		Left	3

## 3. INSTRUMENTS

Instrument set for CHARSPINE2 spine stabilizer - basic [15.0907.001]			
Instrument set for CHARSPINE2 module 1 [15.0907.104]	Name	Catalogue no.	Pcs
	Container lid 9x4	14.0907.104	1
	Container 9x4H	14.0907.101	1
	Compression forceps-jaws W-26 (set) Exchangeable compression jaws are used with compression forceps.	40.5768.026	1
	Compression forceps-jaws W-46 (set) Exchangeable compression jaws are used with compression forceps.	40.5768.046	1
	Distraction forceps-jaws Exchangeable distraction jaws are used with distraction forceps.	40.5769.000	1
	Parallel distraction forceps Distraction forceps are used with exchangeable jaws and are intended for procedure of vertebrae distraction.	40.8093.000	1
	Parallel compression forceps Compression forceps are used with exchangeable jaws and are intended for procedure of vertebrae compression.	40.8094.000	1
	Counter wrench Counter wrench is used to ensure rotational stability of the implants system during final tightening of the locking screws.	40.8095.000	1
	Rod bender 6.0 left Bender is used for bending the rod in situ.	40.8091.000	1
	Rod bender 6.0 right Bender is used for bending the rod in situ.	40.8092.000	1
	Pedicle probe straight Pedicle probe is used to verify the continuity of the vertebral arch pedicle.	40.6698.000	1
	Pedicle probe curved Pedicle probe is used to verify the continuity of the vertebral arch pedicle.	40.6699.000	1











## Instrument set for CHARSPINE2 spine stabilizer - basic [15.0907.001]

Instrument set for CHARSPINE2 module 2 [15.0907.102]	Name	Catalogue no.	Pcs
	Container 9x4H	14.0907.102	1
	Cortical tap 4.0	40.8075.040	1
	Cortical tap 4.5	40.8075.045	1
	Cortical tap 5.0	40.8075.050	1
	Cortical tap 5.5	40.8075.055	1
	Cortical tap 6.0	40.8075.060	1
	Cortical tap 6.5	40.8075.065	1
	Cortical tap 7.5	40.8075.075	1
	Cortical tap 8.5	40.8075.085	1
	Cortical tap 9.5	40.8075.095	1
	Cortical taps are intended for usage with T-type ratchet handles [40.8085.000] or [40.8086.000] and may be used for tapping the vertebral arch pedicle prior to screw insertion.		
	Screwdriver tip T30	40.8084.000	1
	Screwdriver tip T30 is intended to be used with T-type torque handle 12Nm [40.8087.000]. It is used to finally lock the transpedicular screws, hooks and lateral connectors.		
	Screwdriver T30	40.8111.000	1
	Screwdriver T30 is used for application and initial locking of the locking screws.		
	Reduction screw device	40.8108.000	1
	Reduction screw device is used to break off the extended arms of reduction screws.		
	Eye wrench	40.8069.000	1
	Eye wrench is used to prevent the rod from changing its position while bending, and to conduct the rod derotation.		
	Rod impactor	40.8068.000	1
	Rod impactor is used to impact and press the rod down to the transpedicular screw cut-out.		
	Impactor for staples	40.8098.000	1
	Impactor for staples is used for insertion and positioning of double-hole staples.		
	Screwdriver tip T15	40.8110.000	1
	Screwdriver tip T15 is intended to be used only with T-type torque handle 3.5Nm [40.8088.000]. It is used to screw the locking screws into crosswise, axial and parallel connectors.		
	Trocar	40.8073.000	1
	Trocar is used to puncture the cortical layer of the vertebral arch pedicle, as a point of insertion of transpedicular screw.		
	Fork persuader	40.8100.000	1
	Fork persuader is used to press the rod down to the bottom of the transpedicular screw cut-out.		

## Instrument set for CHARSPINE2 spine stabilizer - basic [15.0907.001]

Instrument set for CHARSPINE2 module 3 [15.0907.103]	Name	Catalogue no.	Pcs
	Container lid 9x4	14.0907.104	1
	Container 9x4H	14.0907.103	1
	<b>Screw persuader</b> Screw persuader is used to press the rod down to the bottom of the transpedicular screw cut-out.	40.8096.100	1
	<b>Adjustable rod bender</b> Adjustable rod bender is used to bend the rod to desired shape	40.8074.000	1
	<b>Oval head ratchet handle</b> Oval head ratchet handle is used with wrenches for screws and cortical taps (interchangeably with T-type ratchet handle 40.8085.000).	40.8086.000	1
	<b>Wrench for monoaxial screws</b> Wrench for monoaxial screws is used for insertion and mounting of CHARSPINE2 monoaxial transpedicular screws. It is intended for use with T-type or oval head ratchet handle.	40.8089.100	1
	<b>Wrench for polyaxial screws</b> Wrench for polyaxial screws is used for insertion and mounting of CHARSPINE2 polyaxial transpedicular screws. It is intended for use with T-type or oval head ratchet handle.	40.8090.100	1
	<b>Screwdriver tip for monoaxial screws</b> Screwdriver tip for monoaxial screws [40.6145] is a spare instrument for use with wrench for monoaxial screws [40.8089]. This makes it possible to insert two monoaxial screws by two operators simultaneously.	40.6145.000	1
	<b>Screwdriver tip for polyaxial screws</b> Screwdriver tip for polyaxial screws [40.6146] is a spare instrument for use with wrench for polyaxial screws [40.8090]. This makes it possible to insert two polyaxial screws by two operators simultaneously.	40.6146.000	1
	<b>Thoracic pedicular trocar</b> Thoracic pedicular trocar is used to prepare openings in the pedicle of the vertebral arch in the thoracic section of the spine.	40.8070.000	1
	<b>Universal pedicular trocar</b> Universal pedicular trocar is used to prepare openings in the pedicle of the vertebral arch in the lumbar section of the spine.	40.8071.000	1
	<b>Straight pedicular trocar</b> Straight pedicular trocar is used to prepare openings in the pedicle of the vertebral arch in the lumbar section of the spine.	40.8072.000	1
	<b>Template</b> Template is used for selecting the size of crosswise and rod connectors.	40.5248.000	1
	<b>Holding forceps</b> Holding forceps are used to conduct the rod derotation procedure.	40.6202.000	2



Instrument set for CHARSPINE2 spine stabilizer - basic [15.0907.001]			
Instrument set for CHARSPINE2 module 4 [15.0907.201]	Name	Catalogue no.	Pcs
	Tray 4x4 1/2H	14.0907.201	1
	<b>Pliers for rod</b> Pliers for rod are used to grab and insert the spinal rod.	40.8109.000	1
	<b>Holder for crosswise connectors</b> Holder for crosswise connectors is used for insertion and mounting of clamp and regulated crosswise connectors.	40.8067.000	1
	<b>Holder for rod connectors</b> с соединителями скобообразными).Holder for rod connectors is used for insertion and mounting of rod connectors (which are mounted together with clamp connectors).	40.8076.000	1
	<b>Staple holder</b> Staple holder is used to insert the single-hole staples.	40.8099.000	1
Instrument set for CHARSPINE2 spine stabilizer - basic [15.0907.001]			
Instrument set for CHARSPINE2 module 5 [15.0907.202]	Name	Catalogue no.	Pcs
	Tray 4x4 1/2H	14.0907.202	1
	<b>T-type ratchet handle</b> T-type ratchet handle is used with wrenches for screws and cortical taps.	40.8085.000	1
	<b>T-type torque handle 12Nm</b> T-type torque handle 12Nm is intended to be used with screwdriver tip T30 [40.8084.000] and is used for final tightening of the locking screws into the transpedicular screws, hooks and lateral connectors.	40.8087.000	1
	<b>T-type torque handle 3.5Nm</b> T-type torque handle 3.5Nm is intended to be used only with screwdriver tip T15 [40.8110.000] and is used for final tightening of the locking screws into the crosswise, axial and parallel connectors.	40.8088.000	1
Name			
	Tray 4x1 1/2H	14.0000.201	1

**Instrument set for CHARSPINE2 spine stabilizer - extended 1 [15.0907.002]**  
(instruments for spine hooks)

**Instrument set for CHARSPINE2 module 6 [15.0907.203]**      **Name**      **Catalogue no.**      **Pcs**



Tray 5x4 1/2H

14.0907.203

1



Hook holder

Hook holder is used to insert spinal hooks.

40.8101.000

1



Lateral hook holder

Lateral hook holder is used to insert spinal hooks.

40.8102.000

1

**Instrument set for CHARSPINE2 spine stabilizer - extended 1 [15.0907.002]**  
(instruments for spine hooks)

**Instrument set for CHARSPINE2 module 7 [15.0907.204]**      **Name**      **Catalogue no.**      **Pcs**



Tray 5x4 1/2H

14.0907.204

1



Impactor for hooks

Impactor for hooks is used for final impaction of spinal hook into the selected space.

40.8103.000

1

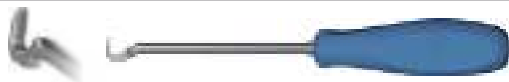

Narrow raspatory for laminar hooks

Narrow raspatory for laminar hooks is used to prepare space for a laminar hook.

40.8104.000

1



Raspatory for laminar hooks

Raspatory for laminar hooks is used to prepare space for a laminar hook.

40.8105.000

1

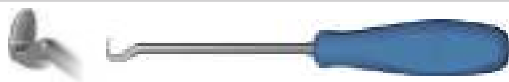

Wide raspatory for laminar hooks

Wide raspatory for laminar hooks is used to prepare space for a laminar hook.

40.8106.000

1



Raspatory for pedicle hooks

Raspatory for pedicle hooks is used to prepare space for a pedicular hook.

40.8107.000

1



















Extended instrument set [15.0907.002] is additional equipment.





In order to include the instruments to the ordered CHARSPINE2 instruments, please contact your local representative or ChM Sales Department.



Instruments mentioned below are not included in the standard instrument set.

In order to include them to the ordered CHARSPINE2 instruments, please contact your local representative or ChM Sales Department.

	Name	Catalogue no.
	<b>Wrench for monoaxial screws - mini</b> Wrench for monoaxial screws - mini is used as an alternative to the standard wrench [40.8089.100] in situations where the conditions of surgery or the surgeon's preferences require the use of a very short instrument.	40.6158.100
	<b>Wrench for polyaxial screws - mini</b> Wrench for polyaxial screws - mini is used as an alternative to the standard wrench [40.8090.100] in situations where the conditions of surgery or the surgeon's preferences require the use of a very short instrument.	40.6159.100
	<b>Screwdriver tip for monoaxial screws - mini</b> Screwdriver tip for monoaxial screws - mini is a spare instrument for use with wrench for monoaxial screws - mini [40.6158.100]. This makes it possible to insert two monoaxial screws by two operators simultaneously.	40.6149.000
	<b>Screwdriver tip for polyaxial screws - mini</b> Screwdriver tip for polyaxial screws - mini is a spare instrument for use with wrench for monoaxial screws - mini [40.6159.100]. This makes it possible to insert two monoaxial screws by two operators simultaneously.	40.6150.000
	<b>Wrench for monoaxial screws short</b> Wrench for monoaxial screws short is used as an alternative to the standard wrench [40.8089.100] in situations where the conditions of surgery or the surgeon's preferences require the use of shorter instrument.	40.8112.100
	<b>Wrench for polyaxial screws short</b> Wrench for polyaxial screws short is used as an alternative to the standard wrench [40.8090.100] in situations where the conditions of surgery or the surgeon's preferences require the use of shorter instrument.	40.8113.100
	<b>Screwdriver tip for monoaxial screws short</b> Screwdriver tip for monoaxial screws short [40.6147] is a spare instrument for use with wrench for monoaxial screws short [40.8112]. This makes it possible to insert two monoaxial screws by two operators simultaneously.	40.6147.000
	<b>Screwdriver tip for polyaxial screws short</b> Screwdriver tip for polyaxial screws short [40.6148] is a spare instrument for use with wrench for polyaxial screws short [40.8113]. This makes it possible to insert two polyaxial screws by two operators simultaneously.	40.6148.000
	<b>Screw persuader</b> Screw persuader may be used as an alternative to the standard persuader 40.8096.100. The instrument can be handled using only one hand.	40.8083.100
	<b>Rod trial 6/300</b> Rod trials are used for initial rough assessment of the size and shape of the rod and to facilitate the selection of the proper size of the spinal rod, in the spinal stabilization procedures using transpedicular screws.	40.5246.300
	<b>Pedicule probe</b> Pedicule probe is used to verify the continuity of the vertebral arch pedicle. The probe is equipped with two tips of different stiffness.	40.6696.000
	<b>Tubular rod bender (2 pcs.)</b> Tubular rod bender is used for bending the rod to the acute angle, especially when stabilization: the sacral bone – iliac ala is performed.	40.6178.000
	<b>Distraction forceps</b> Szczypce dystrykcyjne są używane do przeprowadzenia procedury dystrykcji kręgow. (Distraction forceps are used for distraction of vertebrae.)	40.6176.000
	<b>Compression forceps</b> Compression forceps are used for vertebrae compression.	40.6694.000
	<b>Screwdriver T30 short</b> Screwdriver T30 short is used as an alternative to the standard screwdriver T30 [40.8111] in situations where the conditions of surgery or the surgeon's preferences require the use of a shorter instrument.	40.6151.100
	<b>Thoracic pedicular trocar</b> Thoracic pedicular trocar [40.6243] is used as an alternative to the standard thoracic trocar [40.8070] in situations where the surgeon's preferences require the use of an instrument with an oval handle.	40.6243.000

















	Name	Catalogue no.
	<b>Universal pedicular trocar</b> Universal pedicular trocar [40.6244] is used as an alternative to the standard universal trocar [40.8071] in situations where the surgeon's preferences require the use of an instrument with an oval handle.	40.6244.000
	<b>Straight pedicular trocar</b> Straight pedicular trocar [40.6245] is used as an alternative to the standard straight trocar [40.8072] in situations where the surgeon's preferences require the use of an instrument with an oval handle.	40.6245.000
	<b>Hand hold rod cutter</b> Hand hold rod cutter is used for easy cutting of rods with diameters of 6mm, 5mm and 3.5mm.	40.5288.000
	<b>Container lid 9x4</b>  <b>Container 9x4H</b> Use the container [14.0907.105] with silicone mat [12.0725.000] for storage of the additional instruments ( <i>provided on the customer's request</i> ) of the <b>CHARSPINE2</b> system. This container, depending on the needs, can be included into another container of the <b>CHARSPINE2</b> system or provided with a separate container lid [14.0907.106].	14.0907.106  14.0907.105



Instruments mentioned below are not included in the standard instrument set.

In order to include them to the ordered CHARSPINE2 instruments, please contact your local representative or ChM Sales Department.

**Additional instruments, not included in the set, for bone cement delivery through an open access**

	Name	Catalogue no.	Pcs
	<b>Trocar</b> Trocar is used to penetrate the cortex of the pedicle and to insert the guide rod.	40.8601.000	1
	<b>Guide rod 1.5/500</b> Blunt rod. It is the guiding element for other instruments, e.g. used for screws insertion.	40.8559.000	1
	<b>Cortical tap 4.5</b>	40.8567.045	1
	<b>Cortical tap 5.0</b>	40.8567.050	1
	<b>Cortical tap 5.5</b>	40.8567.055	1
	<b>Cortical tap 6.0</b>	40.8567.060	1
	<b>Cortical tap 6.5</b>	40.8567.065	1
	<b>Cortical tap 7.0</b>	40.8567.070	1
	<b>Cortical tap 7.5</b>	40.8567.075	1
	<b>Cortical tap 8.5</b>	40.8567.085	1
	<b>Cortical tap 9.5</b>	40.8567.095	1
	<b>Cortical tap 10.5</b>	40.8567.105	1
	<b>Wrench for polyaxial screws</b> The wrench is used for polyaxial fenestrated screws insertion through an open access. Should be used with oval head ratchet handle [40.8086.000].	40.6735.100	1
	<b>Cannula for bone cement (short)</b> Single use cannula for bone cement is intended to be used with CHARSPINE2 MIS screws. The universal Luer thread allows the cannula to be connected with a mixing and delivery system for bone cement.	40.8594.000	1
	<b>Wrench</b> Wrench facilitates the removal of the guide sleeve and tightening of the cannula for bone cement.	40.8580.000	1
	<b>Counter wrench</b> Counter wrench is used to immobilize the head of the polyaxial screw when installing/ removing the cannula for bone cement.	40.6749.000	1

Cortical taps are intended for use with oval head ratchet handle [40.8086.000] and may be used for tapping the pedicles prior to fenestrated screws insertion.

## 3.1. CONTAINERS ARRANGEMENT

## Containers for basic instrument set [15.0907.001]

No.	Name	Catalogue No.	Pcs
1	Container lid 9x4	14.0907.104	1
2	Container 9x4H	14.0907.101	1
3	Tray 4x4 1/2H	14.0907.202	1
4	Tray 4x4 1/2H	14.0907.201	1
5	Tray 4x1 1/2H	14.0000.201	1
6	Container 9x4H	14.0907.102	1
7	Container lid 9x4	14.0907.104	1
8	Container 9x4H	14.0907.103	1

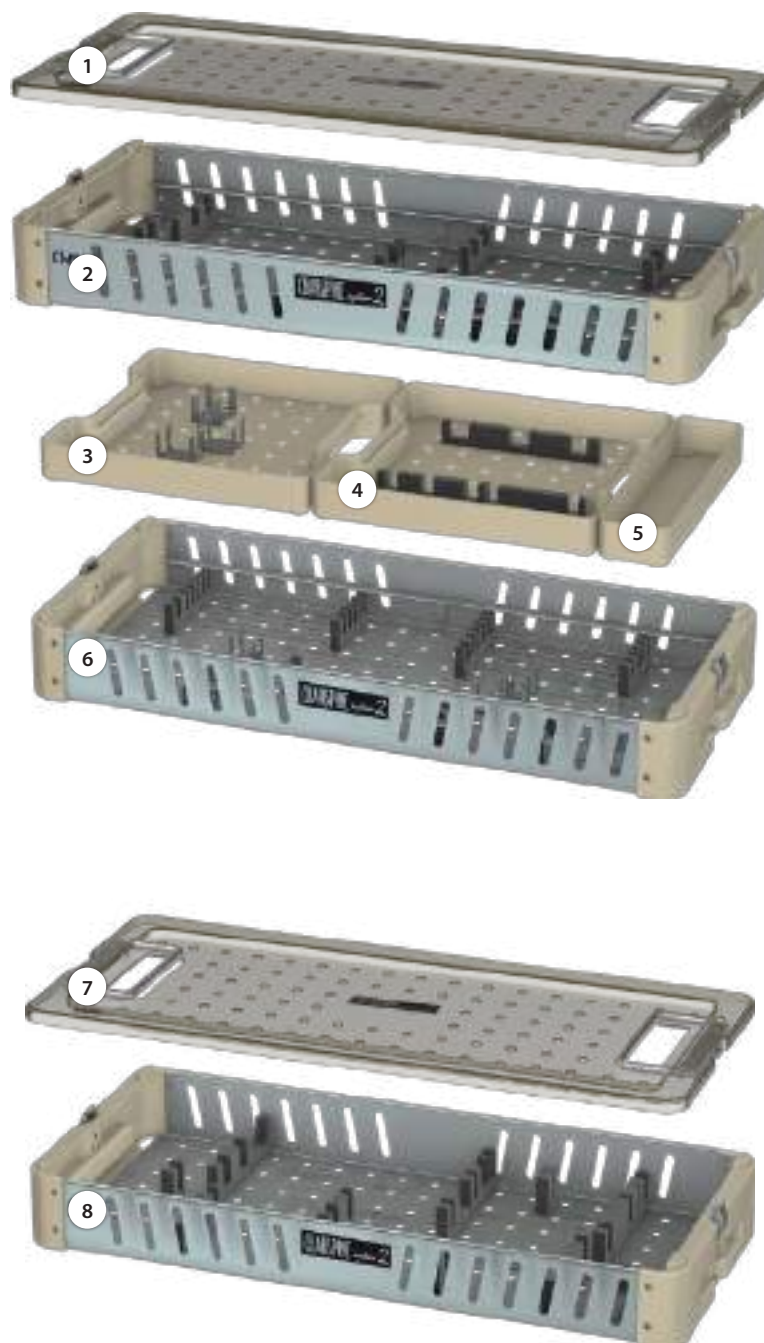

Containers for instrument set:  
- basic [15.0907.001], and  
- extended 1 [15.0907.002].

No.	Name	Catalogue No.	Pcs
1	Container lid 9x4	14.0907.104	1
2	Tray 4x4 1/2H	14.0907.201	1
3	Tray 5x4 1/2H	14.0907.203	1
4	Container 9x4H	14.0907.101	1
5	Tray 4x4 1/2H	14.0907.202	1
6	Tray 5x4 1/2H	14.0907.204	1
7	Container 9x4H	14.0907.102	1
8	Container lid 9x4	14.0907.104	1
9	Container 9x4H	14.0907.103	1

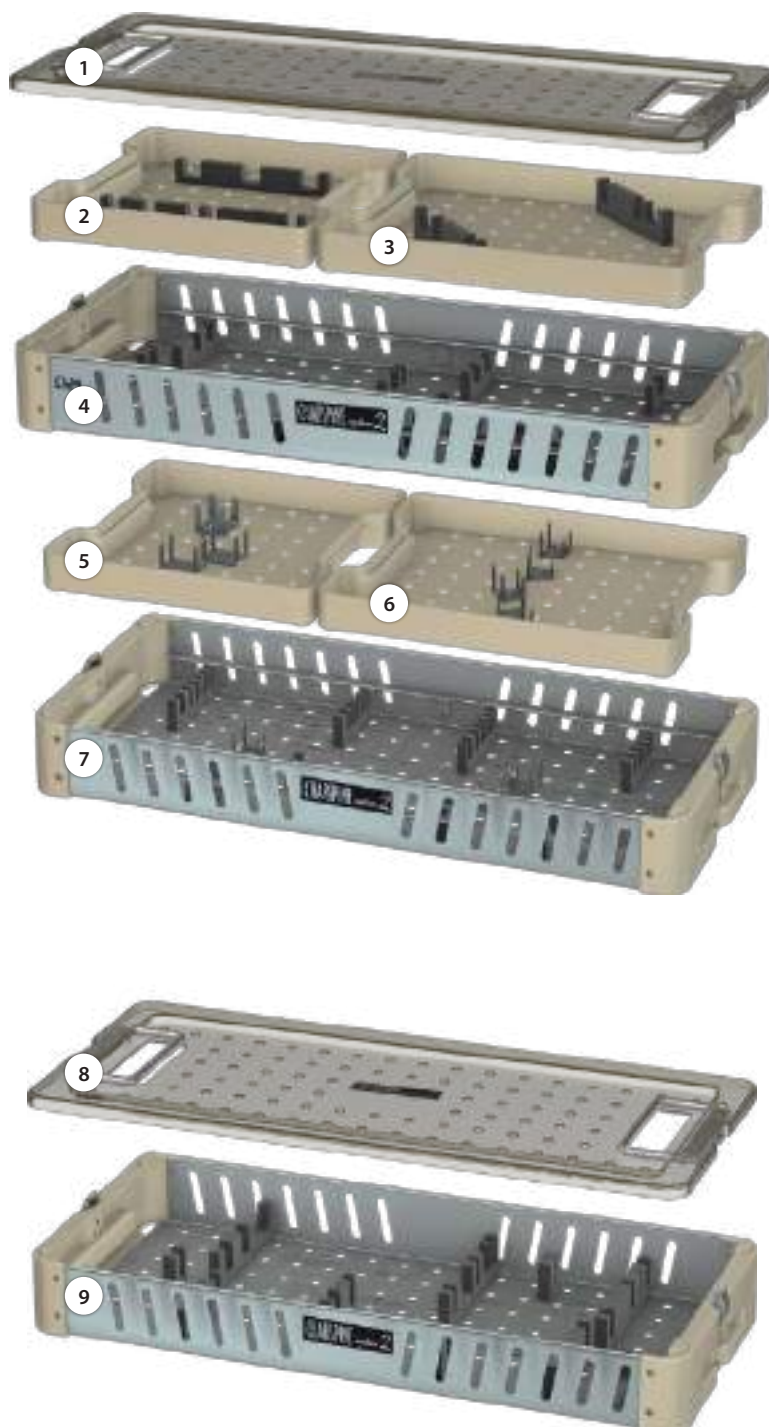

Container 9x4H [14.0907.105] and container lid 9x4 [14.0907.106] are intended for storing additional instruments of CHARSPINE2 system, completed on a client's request.

No.	Name	Catalogue No.	Pcs
1	Container lid 9x4	14.0907.106	1
2	Container 9x4H	14.0907.105	1

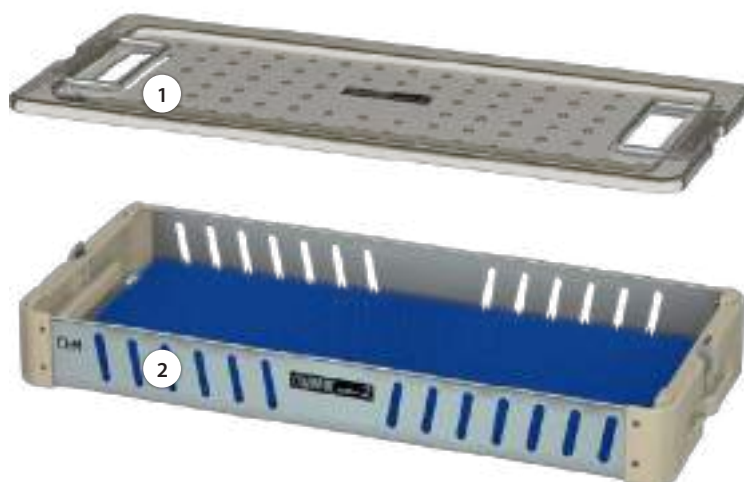



## 4. SURGICAL TECHNIQUE

### Anterior approach to thoracolumbar spine

Surgical procedures on the thoracolumbar spine by means of anterior approach are generally performed with a patient in a lateral position, with the assistance of a general or vascular surgeon.

### 4.1. THORACOTOMY

Thoracotomy is a standard approach for the treatment of thoracic spine disorders such as deformity, tumor or infection. In case of deformity treatment, the approach is always located on the side of the curve apex, e.g. a right-sided thoracotomy is chosen for a right-sided curve. In general, a left-sided thoracotomy is preferred, especially in the lower thoracic area, due to right-sided location of the liver which limits the operative field. However, when the upper part of the thoracic spine is concerned, some surgeons favour right-sided approach (*in cases when the spinal pathology does not dictate the side of thoracotomy*) to avoid subclavian and carotid arteries in the left superior mediastinum.

#### Indications

Spinal pathologies (*deformities, degenerations, fractures, tumours, infections*) that are located between T4 and T10 are indications for the thoracotomy.

#### Patient positioning

In case of right-sided thoracotomy, the patient is lying on the left side on a soft, rubber mattress. The arms are positioned at elevation of 90° and with the elbows flexed. The legs are kept straight, with the right leg resting on the left leg. The symphysis and the sacrum are supported by pads to maintain the specified position. Prior to skin incision, the side of thoracotomy and the level involved are to be confirmed. It is essential to center the incision right over the pathology place and to select the intercostal space correctly. To confirm the selected spine level, it is recommended to count the ribs and to compare the result with the radiograph.

The skin incision shall be extended from the lateral border of the paraspinous muscle up to the sternocostal joint.



## 4.2. ANTERIOR THORACOLUMBAR APPROACH

The anterior approach to thoracolumbar section may be used if there is a need of simultaneous exposure of vertebral bodies of lower thoracic and upper lumbar parts of the spine. Technically, this approach is more difficult than thoracotomy because of the diaphragm exposed and the increased risk of simultaneous exposure of the thoracic cavity and the peritoneal space. If the spine pathology does not determine the side of the approach, the access from the left side is preferred due to right-sided location of the liver.

### Indications

The anterior thoracolumbar approach is recommended for spine pathologies mentioned as an indication for thoracotomy and situated between T9 and L5.

### Patient positioning

The patient is placed in the right lateral decubitus position, with supports placed beneath the thorax and shoulders. The table may be slightly bent above the level of pelvis to increase the distance between pelvis and thorax.

During the operation special care should be taken to not harm the branches of the phrenic nerve, which are extending peripherally from the center towards anterolateral and posterior direction. It is recommended to make the incision around the periphery of the diaphragm to minimize the interference with its function when making the thoracoabdominal approach to the spine.

Special care should also be taken when entering the abdominal cavity.

To gain the best access to the space between T12 and L1, it is usually recommended to resect the tenth rib which allows exposure between T10 and L2.

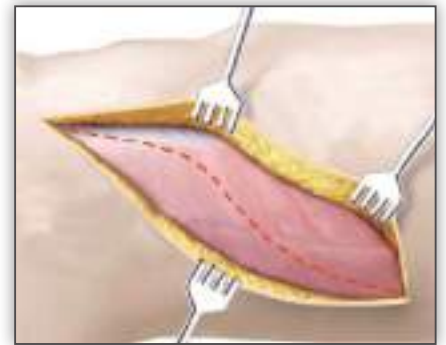

## 4.3. ANTERIOR RETROPERITONEAL APPROACH

The anterior retroperitoneal approach to the lumbar vertebral bodies is a modification of the anterolateral approach commonly used by general surgeons during the sympathectomy. It allows for superior, multilevel access to the lumbar spine.

### Indications

The anterior retroperitoneal approach is recommended for spine pathologies (*deformities, degenerations, fractures, tumours, infections*) situated between L2 and L5.

### Patient positioning

The patient is placed in the decubitus position, in most cases on the right side. Most often, the approach is made from the left side to prevent damage to the liver and the inferior vena cava. To better expose the space between the twelfth rib and the iliac crest, the table planes may be flexed. Lower limbs are bent slightly in hips to release the tension of the psoas muscle.

The incision is to be oblique, above the twelfth rib, from the lateral border of the quadratus lumborum muscle to the lateral border of the rectus abdominis muscle, in order to allow access to the first and second lumbar vertebrae.

When the lower vertebrae (*from L3 to L5*) are exposed, the incision is to be made a few fingers below and parallel to the costal margin.

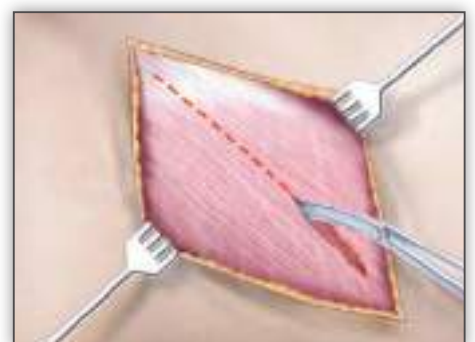

#### 4.4. POSTERIOR APPROACH TO THE THORACOLUMBAR APPROACH

The posterior approach to the thoracolumbar spine can be made through standard midline longitudinal incision with lateral retraction of the erector spinae in the direction of the transverse processes tips. This approach allows for access to the spinous processes, vertebral arches and joints at all levels.

The target spine level should be determined using the X-Ray control, so that the spine is unveiled only at the required segment.

##### Indications

The anterior approach to the thoracolumbar spine is recommended for spine pathologies (*deformities, spine canal stenoses, fractures, degenerations, tumours, infections, instabilities, herniations*) situated between T1 and L5.

##### Patient positioning

Patient is placed prone on rubber-foam supports. To avoid excessive pressure and pressure sores, a headrest with support for mouth, nose and eyes should be used. It is vital to avoid any pressure on the abdomen. It is crucial while decompressing the spine, as pressure on abdomen may cause vein congestion and thus excessive intraoperative bleeding.

Positioning the patient on a bending surgical table with supports with flexion of hip and knee joints allows for reduction of lumbar lordosis and easier access to posterior spine elements and spine canal structures, especially at the lumbosacral junction.

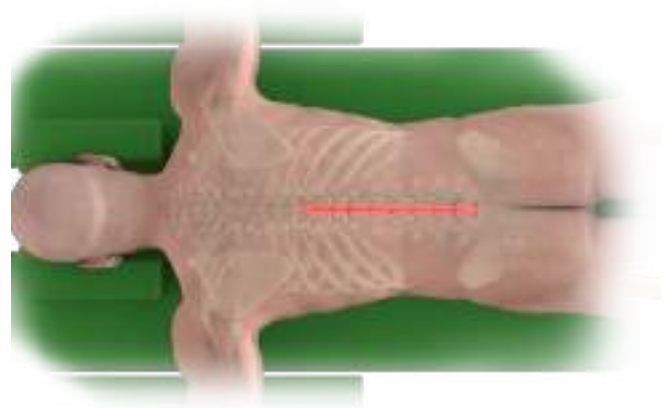

#### 4.5. APPROACH TO POSTERIOR SUPERIOR ILIAC SPINE

##### Indications

This approach is recommended when the following occur: a significant lumbopelvic instability (*caused by damage at S1 level resulting from trauma, tumour or infection*) or long thoracolumbosacral instrumentation of scoliosis, causing a high risk of instability of the lumbosacral connection.

##### Patient positioning

Patient is positioned in the same manner as presented in section IV.4.

Screw implantation in pelvis requires access to the posterior superior iliac spine. First, the lumbosacral spine is exposed. The posterior superior iliac spine may be exposed with a separate, longitudinal skin incision, bilateral resection of the myofascial flaps and retraction in lateral and cephalad direction.

The entry point is located at the lower part of the posterior superior iliac spine. It is recommended to use osteotome (*or rongeur*) to remove a fragment of the iliac crest around the screw head or to sink the screw head in the bone to avoid any screw prominence, especially when slim patients are concerned.

### 4.6. SCREW SELECTION. PREPARATION OF THE SCREW ENTRY POINT

During transpedicular stabilization it is of vital importance to select appropriate screw diameter for specific vertebrae and to carefully choose the site and a angle of insertion. Depending on the location level, the pedicles of vertebrae arches are varied in terms of shapes and geometry (e.g. the cross section of the vertebrae arch pedicles in the thoracic spine indicates an irregular, kidney-like shape with the medially-directed convexity).

Taking into consideration the above-mentioned, the initial selection of screw diameter and length has to be performed within the preoperative procedures, individually for each vertebrae on the basis of CT and X-Ray images (in AP and lateral projections).

The internal dimension of the arch of a vertebrae pedicle ( $W$ ) is of vital importance when choosing the external diameter of the transpedicular screw. It is crucial to remember that the pedicle dimensions obtained on the basis of imaging in AP projection are not real dimensions and should be treated as approximate values only. In general, the outer diameter of the screw is 2 mm smaller than the internal dimension of the vertebrae pedicle arch.

Screw insertion point is located at the intersection of a line that divides the transverse processes in half and the line along the lateral aspect of the superior articular process.



The surgeon shall decide about the size of screws on the basis of CT and X-Ray imaging and intraoperative identification (probing the pedicle).

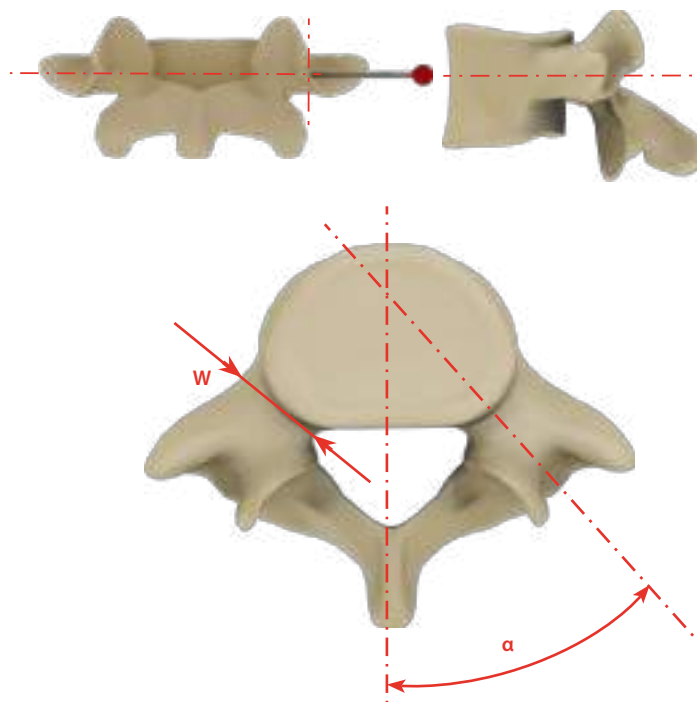

There are two alternative trajectories for insertion of screws through the thoracic vertebrae pedicles:

- A – anatomical approach
- B – straight approach (direct)

The insertion point is located at the intersection of a line in sagittal projection about 1 mm in medial direction from the lateral edge of the lamina and of a line along the transverse processes about 1 mm below the surface of the superior articular process.



If anatomical approach is used, only polyaxial screws are to be used.  
If straight (direct) approach is used, both normal and polyaxial screws may be used.

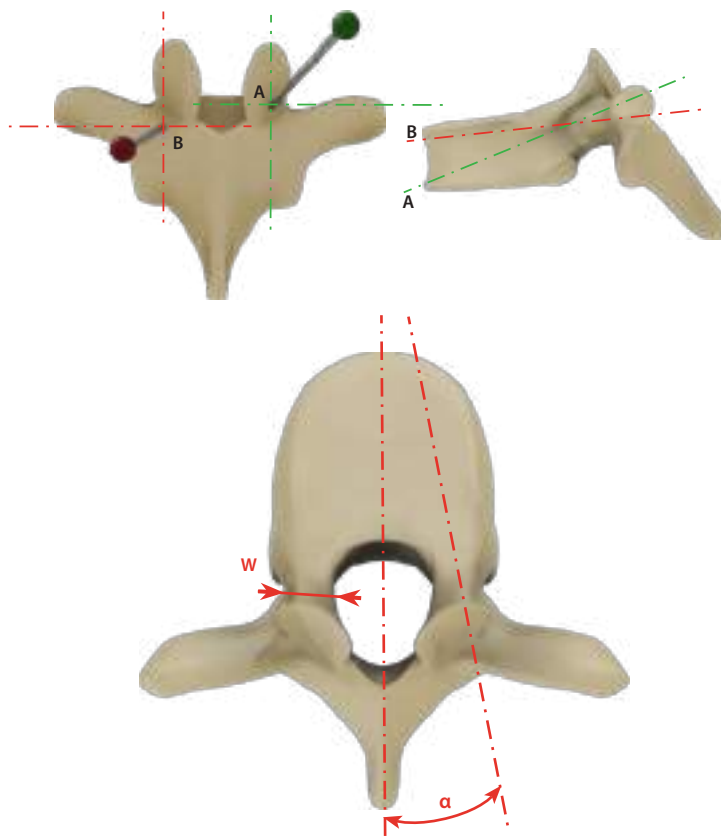

## 4.7. INSERTION OF SCREWS. POSTERIOR APPROACH

### 4.7.1. PREPARATION OF VERTEBRAL ARCH PEDICLES



The point of screw insertion is prepared with a trocar [40.8073.000] which is used to puncture the cortical layer of the vertebral arch pedicle.

When it is necessary a bone rongeur is used to remove the upper part of the vertebral articular process at the screw insertion point, therefore the cancellous bone right under the cortical layer and the access to the vertebral arch pedicle are exposed.

Pedicle diameter and the angle should be determined prior to the operation by means of imaging studies. It allows for later determination of depth and angle of the prepared canal and the screw diameter.



An opening for screw is prepared with the use of a pedicular trocar (which is available as: universal [40.8071.000], straight [40.8072.000] and thoracic [40.8070.000]).

The instrument is inserted by means of delicate rotary-oscillatory movement.



The tip should be inserted carefully, led along the interior walls of the vertebral cortical bone with the smallest resistance possible, so the vertebra walls remain undamaged.



Trocar tip has marked depth indicators in five-millimeter increments to help determine the correct length of the transpedicular screw.

Identical procedure should be used while preparing the opening in the second pedicle.



	40.6698.000
	40.6699.000



Prior to screw insertion, it is recommended to check the continuity of all walls of the vertebral arch pedicle with the help of the pedicle probe [40.6698] or [40.6699].



	40.8075.040
	40.8075.045
	40.8075.050
	40.8075.055
	40.8075.060
	40.8075.065
	40.8075.075
	40.8075.085
	40.8075.095
	40.8086.000
	40.8085.000

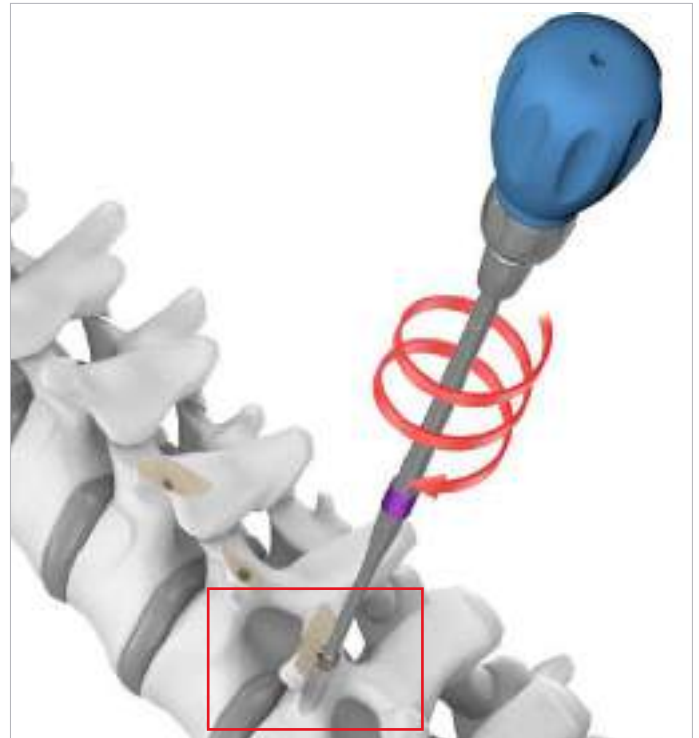

**CHARSPINE2** screws are self-tapping, therefore there is no need to tap the vertebral arch pedicle. However, if tapping is clinically required, it is possible to use taps [40.8075.040÷40.8075.095] mounted on oval head ratchet handle [40.8086.000] or T-type ratchet handle [40.8085.000].



If screws with a double thread are planned to be implanted, use compatible taps with a double thread which are not included in the standard instrument set. To include taps for double-threaded screws to the standard instrument set for stabilizing the spine - **CHARSPINE2** [15.0907.001] - please contact your local representative or **ChM** Sales Department.



Before threading, make sure that the tap is compatible with the screw that will be implanted.

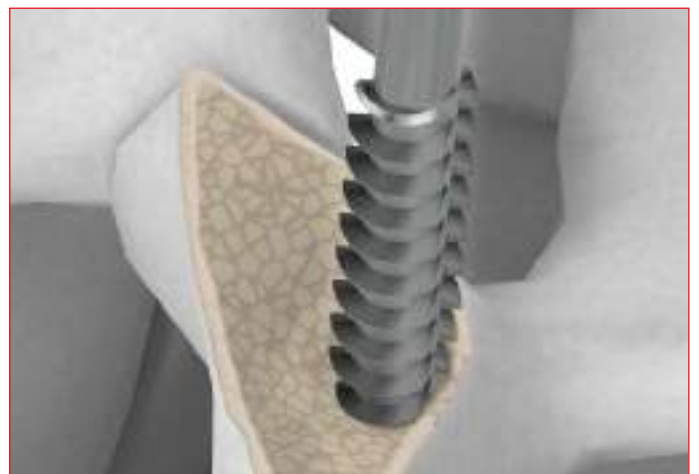

4.7.2. INSERTION OF SCREWS

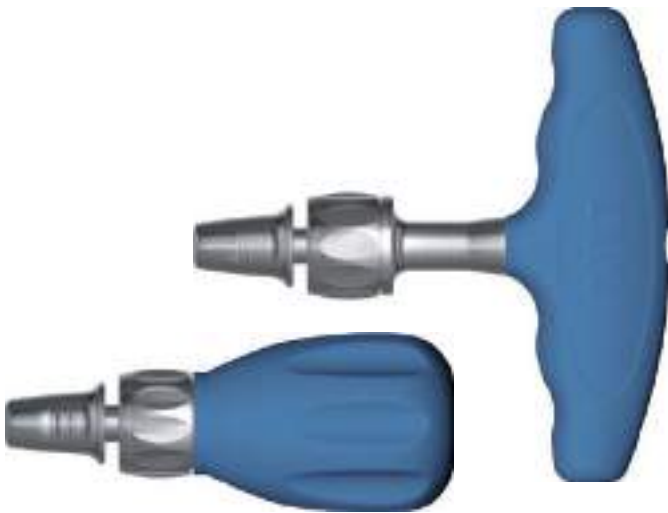

	40.8085.000
	40.8086.000
	40.8089.100
	40.8090.100

Wrenches for monoaxial [40.8090.100] and polyaxial screws [40.8089.100] are intended to be mounted on:

- T-type ratchet handle [40.8085.000],
- oval head ratchet handle [40.8086.000].

Monoaxial and polyaxial wrenches have a ratchet mechanism that prevents any spontaneous loosening of the tip-screw connection during the transpedicular screws insertion.



Tips 1 and 2 of wrenches for screws are exchangeable. In order to disconnect the tip from the wrench [40.8090] or [40.8089], press and hold the PUSH and then remove the tip from the wrench sleeve.

The instrument set is equipped with additional tips for monoaxial [40.6145] and polyaxial [40.6146] screws. Therefore, e.g. two wrenches for polyaxial screws may be used by two operators simultaneously.

Wrench for monoaxial screws [40.8089.100]

Wrench for polyaxial screws [40.8090.100]



Square end of the wrench is mounted in the quick coupling end of the handle [40.8085.000] or [40.8086.000].



Then an appropriate length and diameter of the transpedicular screw (*mono- or polyaxial*) is selected.

The tip is inserted all the way into the screw channel:

- in the case of monoaxial screws, a tip of wrench for monoaxial screws is to be used.



- in the case of polyaxial screws, a tip of wrench for polyaxial screws is to be used.



By turning the knob clockwise, tighten the threaded, external wrench sleeve all the way until the tip is completely seated at the bottom of the screw channel. Tightening direction is marked using arrow and MOUNT sign.

While tightening, with increasing resistance, the wrench knob automatically activates locking mechanism that will prevent the screw from being released from the wrench.





The screw mounted on a wrench is inserted into an opening prepared beforehand.



Screw insertion should be controlled in two planes with the help of X-Ray control.



Remember that precise positioning of the screws is realised by screwing in, and not by screwing out.



Moving back the screw may result in loss of connection stability and may necessitate the use of a larger diameter screw.



When screwing in, do not hold your hand on the oval handle of the wrench for screws, as this will cause the locking mechanism to disengage. If there is a need to use the other hand to hold the wrench, grasp the sleeve portion below the knob.

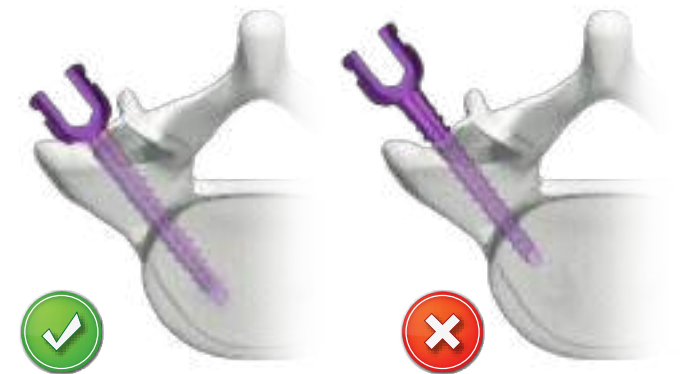

The core of the transpedicular screw is strengthened in the vicinity of its head.

To reduce the potential risk of screw breakage, it is necessary to screw it all the way in so the whole thread is in the bone.



To remove the wrench from the screw, turn knob counter-clockwise as shown by the arrow and DISMOUNT sign.

The locking mechanism of the wrench will disengage automatically.

4.7.3. ROD SHAPING

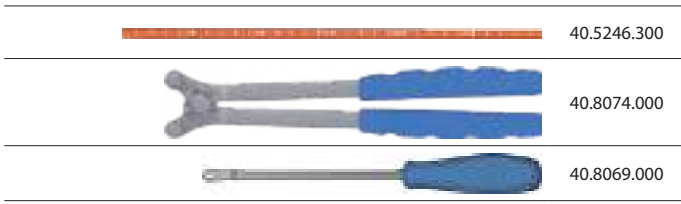

Having inserted the screws, a rod of appropriate length to the instrumented part of the spine should be selected.



In order to determine the approximate length and the desired shape of the rod, rod trial [40.5246.300] can be used.

To achieve the desired spine curvature (e.g. lordosis or kyphosis), the rod should be appropriately shaped. Shaping is performed with the help of adjustable rod bender [40.8074.000]

To secure the rod against movement during shaping, eye wrench [40.8069.000] should be used.



CHARSPINE2 system allows the usage of rods of two types of rigidity:

1.		Rod Ø6 made of titanium alloy in accordance with ISO 5832-3/ASTM F 136	standard rigidity
2.		Rod Ø6 made of cobalt alloy in accordance with ISO 5832-12/ASTM 1537	very high rigidity

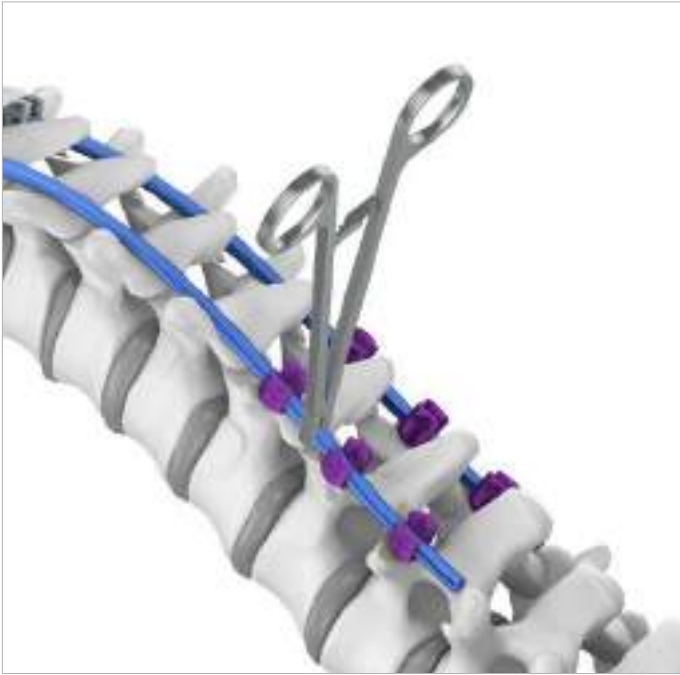

40.8109.000

Appropriately shaped rods are inserted into cut-outs of transpedicular screws with the help of pliers for rod [40.8109.000].

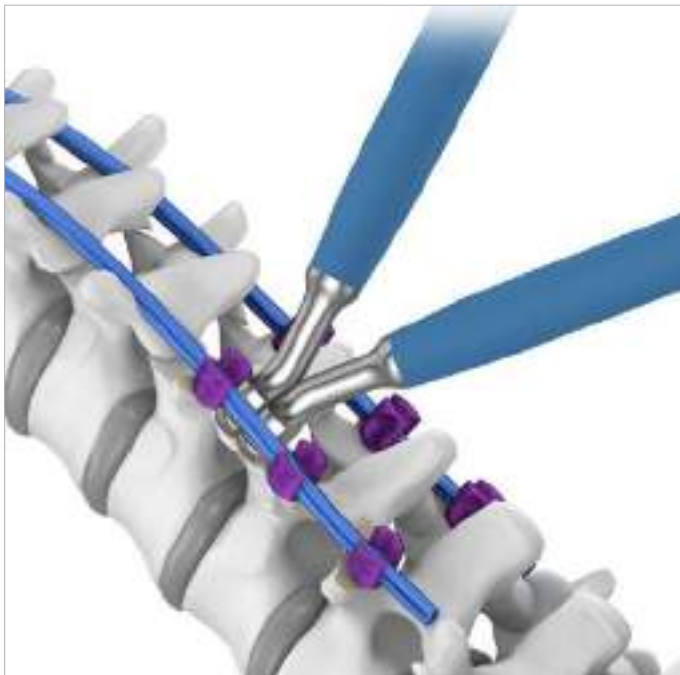

40.8091.000



40.8092.000

To correct the shape of the rod in situ, use the rod benders - right [40.8092.000] and left [40.8091.000].



40.5288.000

If necessary, cut the rod to the desired length with the use of hand held rod cutter [40.5288].



Hand hold rod cutter is a non-standard instrument and is not included into the CHARSPINE2 instrument sets.

## 4.7.4. ROD FIXATION

The rod is locked by inserting the locking screw [3.6160.000] into the transperpendicular screw head.



The locking screw may be mounted on the screwdriver tip only from the upper side of the screw (the locking screw design eliminates any errors related to the mounting).



The upper surface of the screw is colour-marked to allow for easier identification.



40.8111.000

The locking screw is mounted on the tip of the screwdriver T30 [40.8111.000], then it is inserted into the cut-out on the screw head and screwed in slightly in a clockwise direction, simultaneously gently pressing the rod to the screw cut-out bottom.



40.8068.000

In case of difficulties when pressing the rod to the screw cut-out bottom, it is possible to use rod impactor [40.8068.000].

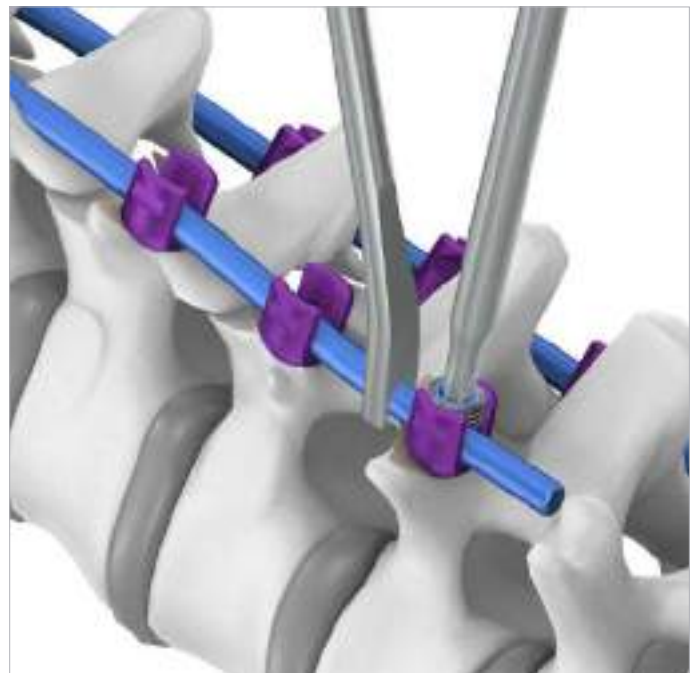

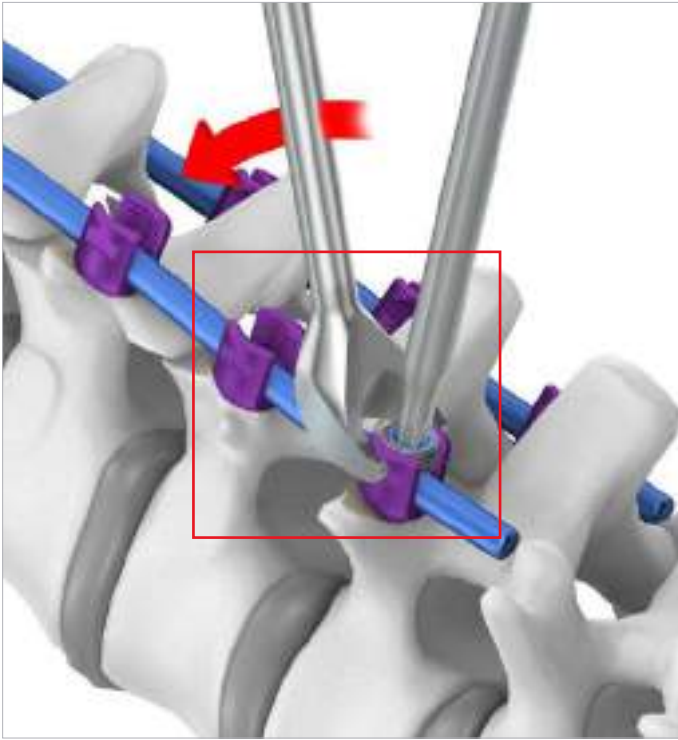

40.8100.000

To press the rod to the screw cutout bottom, it is possible to use also fork persuader [40.8100.000].

The fork persuader [40.8100.000] is of special design that allows its use even when the adjacent screws are very close to each other.

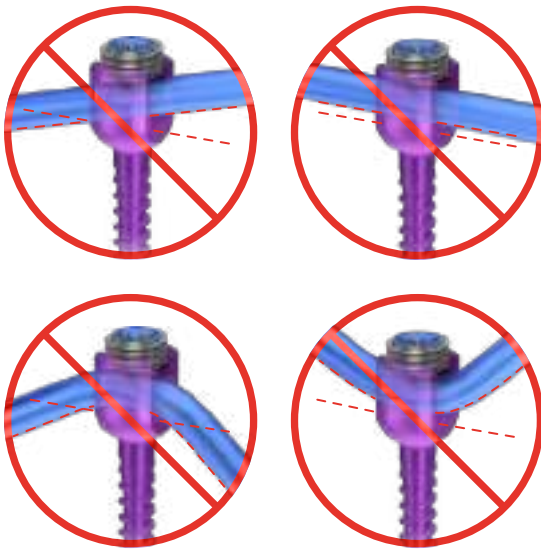
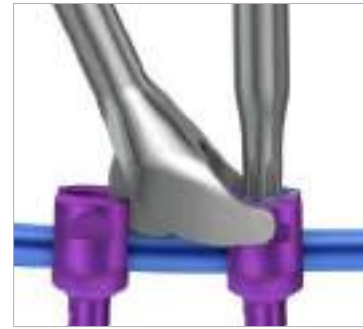

It is necessary to make sure that the rod and locking screw are completely mounted on the bottom of the screw head:

- the rod must be tangent to the cut-out bottom in the screw head,
- the upper part of the locking screw (in blue) should flush with the upper part of the screw head.



It is necessary to avoid the following:

- the rod is not placed horizontally in the screw head,
- the rod is high and does not adhere to the bottom of the screw head cut-out,
- the screw is embedded in the place of rod bending (on the convexity or concavity of the arch).



When the osteosynthesis covers more than three vertebrae, there is a risk that the rod may not fit to all screws cut-outs. In such case reduction screws are of help (with prolonged, breakable head arms). Alternative positioning of a few reduction screws allows for easy pressing the rod with a locking screw into the desired position.

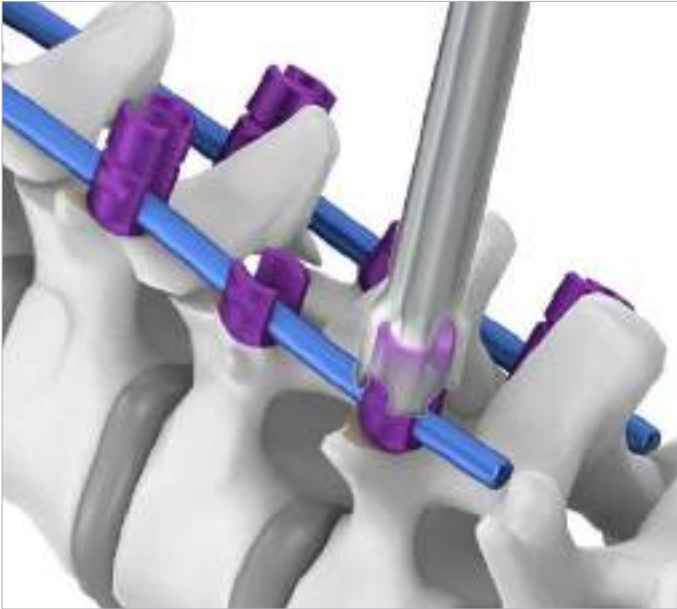

When the long arms spread while inserting the locking screw, first put the counter wrench [40.8095.000] on the screw head and press the rod, then screw in the locking screw until the rod is completely pressed to the screw head bottom.



40.8108.000

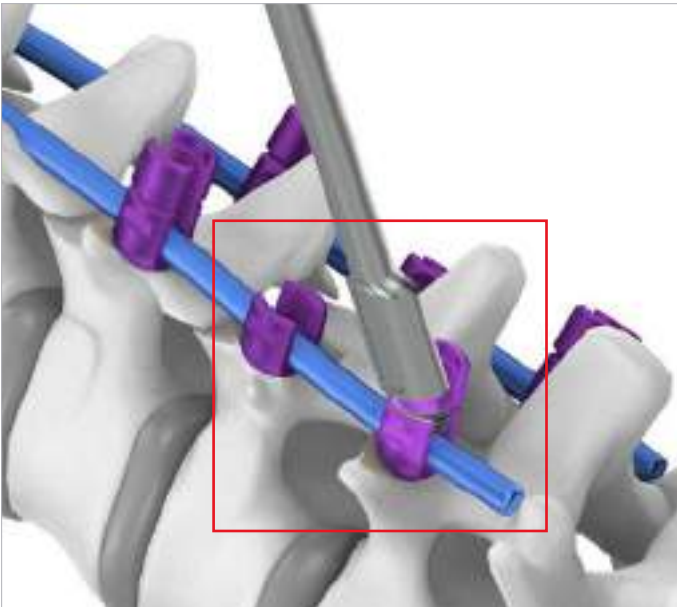

Screws arms are broken off at the end of the surgery with the use of reduction screw device [40.8108.000].



The abovementioned procedure may cause excessive reduction of screws (*and vertebrae*); to avoid this it is necessary to correct the rod bending in situ.



The use of polyaxial screws allows for adjusting the screw head position in relation to the rod, especially when the screws are not parallel. In this manner the connection achieves greater stability and there is no need for complicated rod bending. It is possible to tilt the screw head in any direction.

The use of uniplanar screws gives the possibility to tilt the head of the screw in the rostral-caudal direction, while ensuring medial-lateral stiffness.

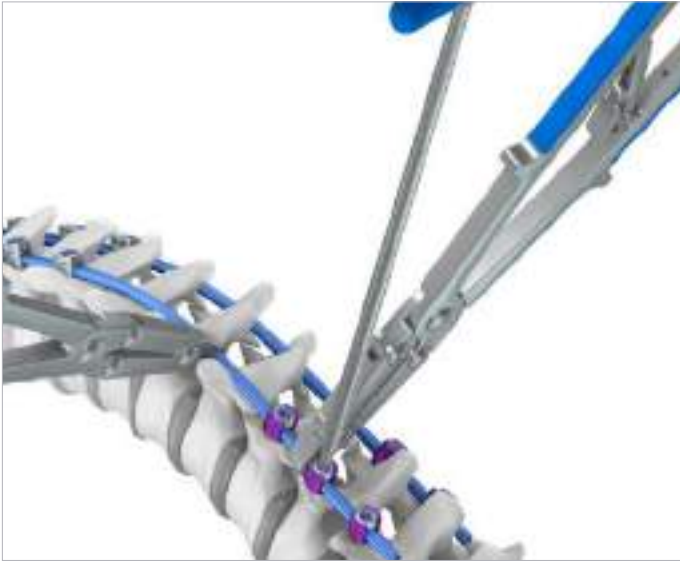

40.6202.000

It is possible to use the holding forceps [40.6202.000] during the procedure of rod derotation.

In such case, having established the desired rod position, the rod should be locked to maintain its position.

This allows for the next stage to be performed - the reposition of vertebrae.



40.8093.000



40.8094.000



At this stage it is possible to perform:

- the vertebrae distraction with the use of parallel distraction forceps [40.8093.000],
- the vertebrae compression with the use of parallel compression forceps [40.8094.000].



A proper shaping of rods is a crucial stage of surgery allowing for good vertebrae reposition.





If more force is necessary to impact the rod into the bottom of the transpedicular screw cut-out, it is possible to use screw persuader [40.8096.100].



Prior to use, extend the clamping arms of the persuader as far as possible by turning the knob counterclockwise until a distinct resistance is felt.



Incompletely extended clamping arms of the persuader may cause the instrument to be improperly connected with the screw and may damage the device.

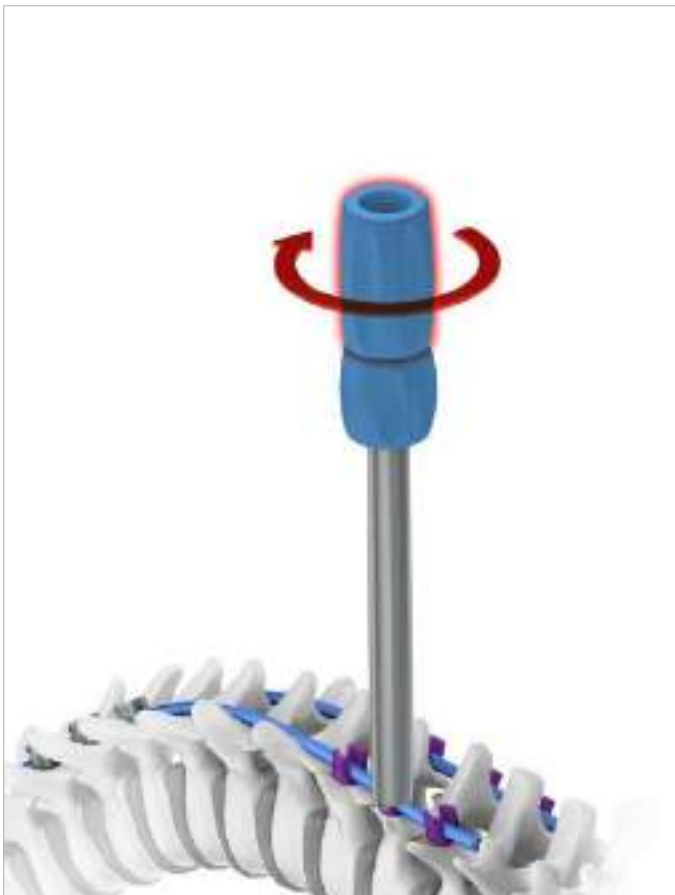

Then, by turning clockwise, the rod may be smoothly pushed down to the bottom of the screw.

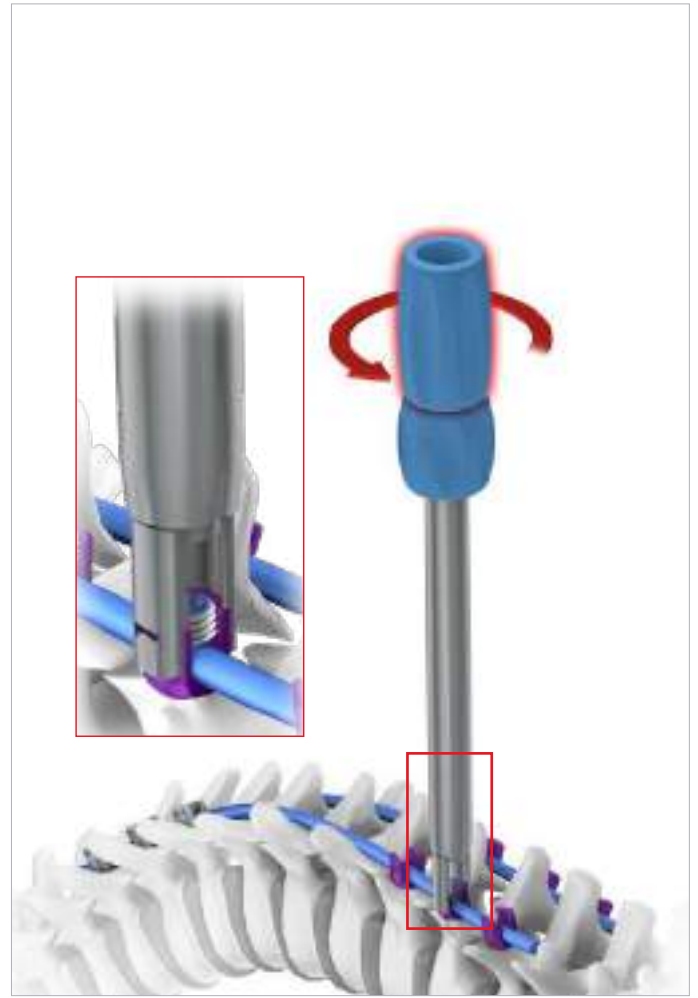

Then turn the persuader knob counterclockwise to loosen the device and extend the clamping arms completely.

To secure the rod, insert the locking screw through the cannulated opening of the screw persuader (the screw is mounted on the screwdriver tip T30 [40.8111.000]) and initially screw it in.

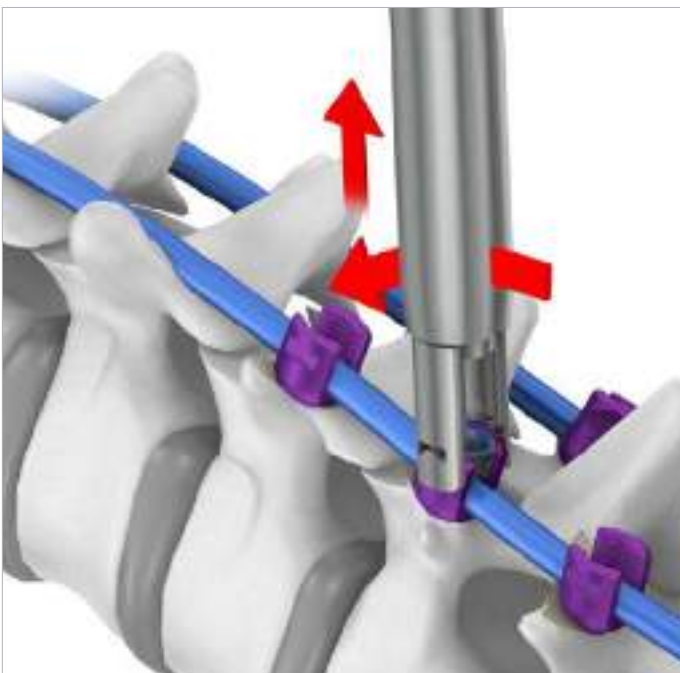

The device is dismantled from the transpedicular screw by skewing the device in the rostral-caudal direction.



Incompletely extended clamping arms of the persuader may damage the device while dismantling.

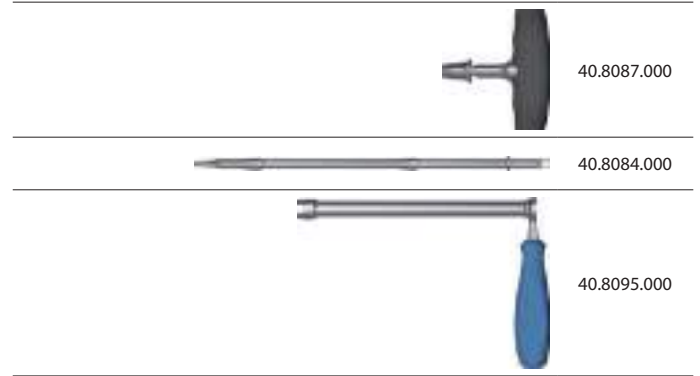

Having established the required vertebrae position, finally screw in the locking screws with the help of T-type torque handle 12Nm [40.8087.000] connected with screwdriver tip T30 [40.8084.000].

When the required torque of 12Nm is reached, the dynamometric mechanism signals it with an audible snap.

To eliminate the movement of rod-screws system while screwing in the locking elements use the counter wrench [40.8095.000].



To maintain high level of safety and correctness of operation of the torque wrench, it is necessary to keep the calibration date presented on the stopper of the instrument handle.

The instrument calibration is performed by the manufacturer - ChM sp. z o.o.

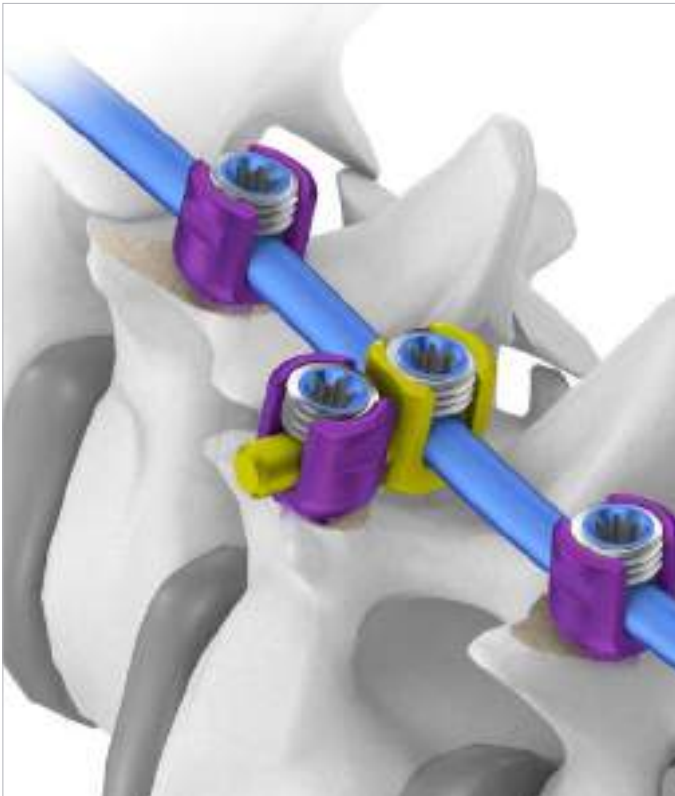

If it is needed to lengthen the fixation in lateral direction (*in relation to the main axis of stabilization*), it is possible to use a lateral connector. The connector is put on the main rod, then it is locked in a desired position (*after mounting the appropriate transpedicular screw*).



When it is necessary to use two sections of rods (e.g. in case of scolioses), it is possible to use the following connectors:

- crosswise connector,
- parallel connector.

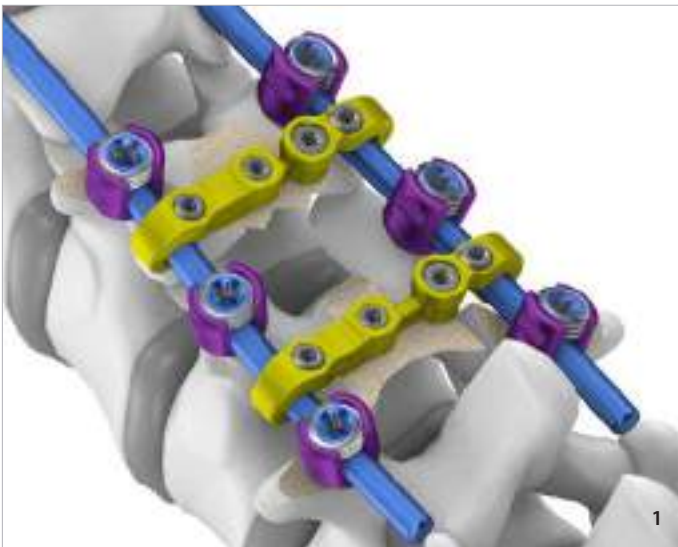

**CHARSPINE2** allows for increase of rotational stability of the system by connecting two sides of rods with the help of a crosswise connector.

**CHARSPINE2** offers three types of crosswise connectors:

1. regulated crosswise connectors.
2. clamp crosswise connectors with rod connectors.
3. solid crosswise connectors (intended for dual-rod stabilization with an anterior approach).

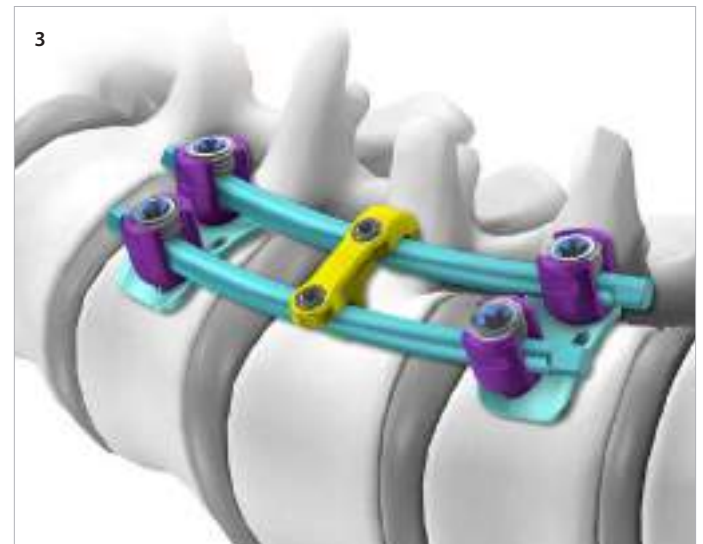



Crosswise connectors are inserted with the use of holder for crosswise connectors [40.8067.000]

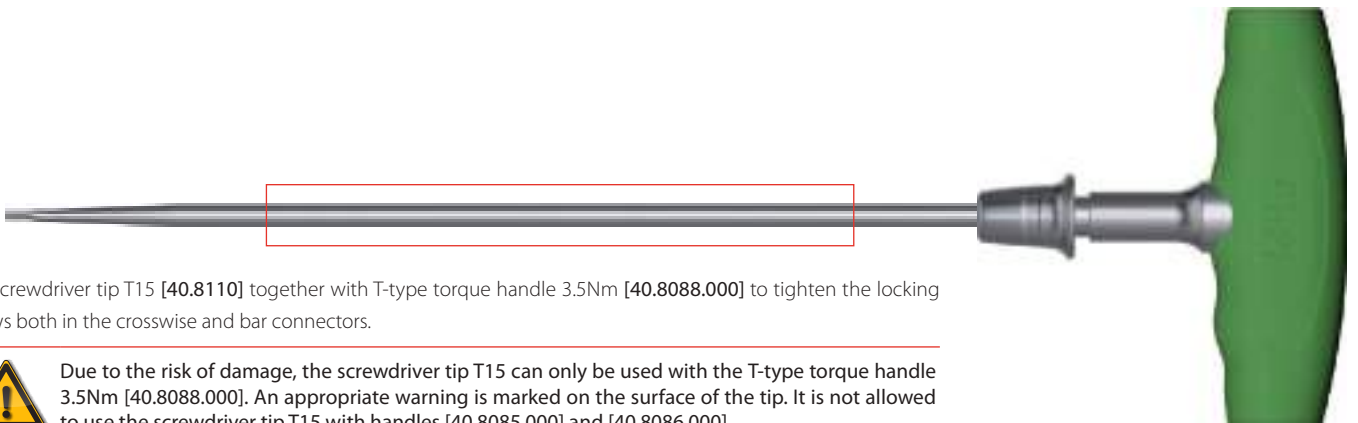

Use screwdriver tip T15 [40.8110] together with T-type torque handle 3.5Nm [40.8088.000] to tighten the locking screws both in the crosswise and bar connectors.



Due to the risk of damage, the screwdriver tip T15 can only be used with the T-type torque handle 3.5Nm [40.8088.000]. An appropriate warning is marked on the surface of the tip. It is not allowed to use the screwdriver tip T15 with handles [40.8085.000] and [40.8086.000].



To facilitate the selection of appropriate length of the crosswise connector, use the template [40.5248.000]

#### 4.8. INTRODUCTION OF POLYAXIAL SCREWS INTO THE PELVIS

Polyaxial screws for pelvis extend the lumbosacral stabilization and provide the fixation in the pelvic bone. The screw offers an increased, asymmetrical range of motion in one of the planes, facilitating screw-to-rod fixation.

The screw insertion hole is prepared using a universal [40.8071.000] or straight pedicular trocar [40.8072.000].



Pedicular trocar may not provide an opening corresponding to the full length of the screw for pelvis. This should be confirmed intraoperatively by X-Ray imaging.

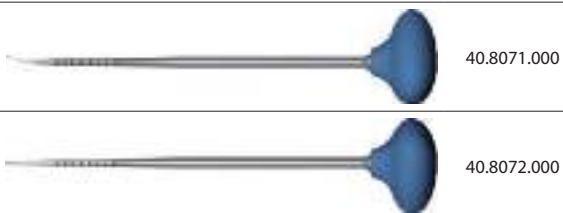

The optimum insertion trajectory of the screw for pelvis starts above the incisura ischiadica major and ends in the quadrilateral area of the pelvic bone above the linea glutea inferior. This trajectory ensures optimum fixation of the screw in the bone.

Polyaxial screw of a determined size is screwed into the prepared pelvic opening using the wrench for polyaxial screws [40.8090.100], attached to the T-handle [40.8085] or oval handle [40.8086].

It is recommended to use osteotome (*or rongeur*) to remove a fragment of the iliac crest around the screw head or to sink the screw head in the bone to avoid any screw prominence, especially when slim patients are concerned.

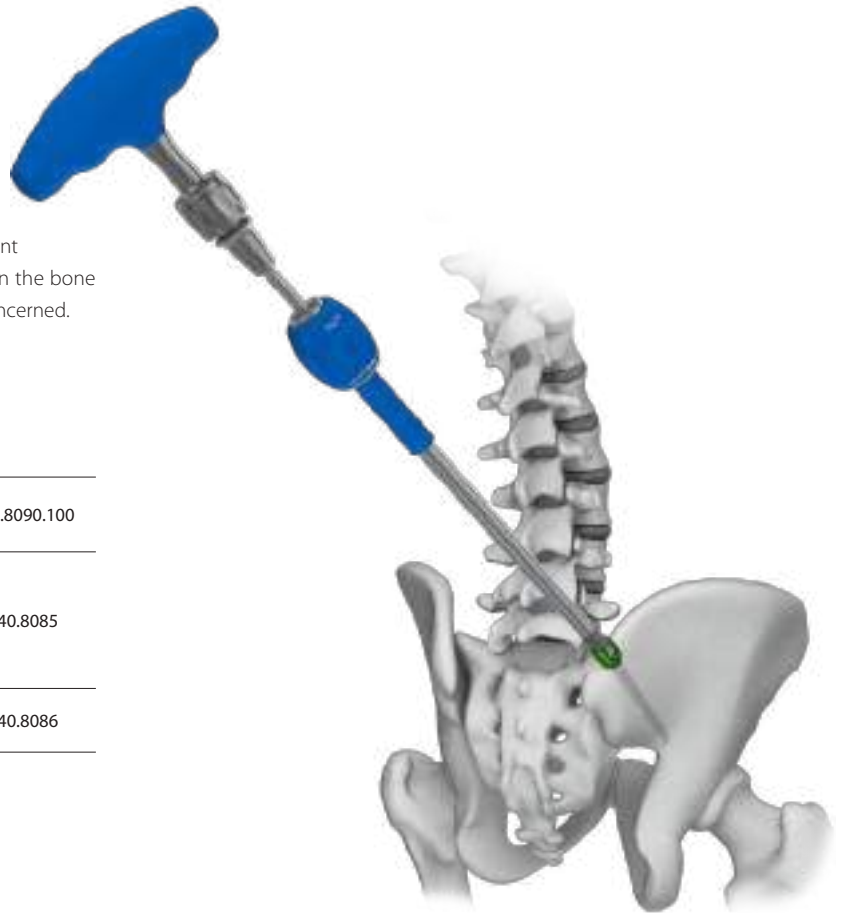
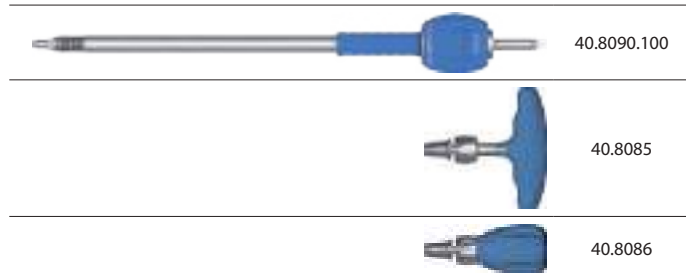

Most often the standard straight rod, e.g. [3.3246.xxx] is used for stabilization. The rod should be profiled so that the screw inserted into the S1 vertebra can be connected with the screw inserted into the pelvis.

It is also possible to use factory profiled rod, e.g. [3.3981.xxx] should any difficulties with rod shaping appear.

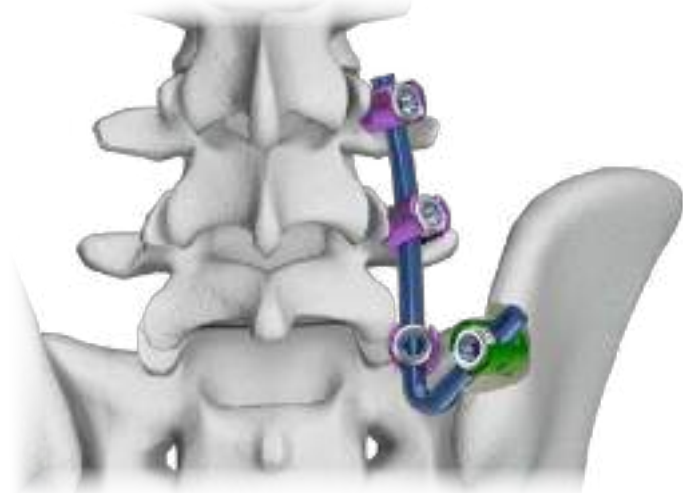

A lateral connector, e.g. [3.6283.xxx] may also be used to connect the rod with the screw inserted into the pelvis.

Locking of the polyaxial screw for pelvis is performed in the same way as for standard polyaxial screws.

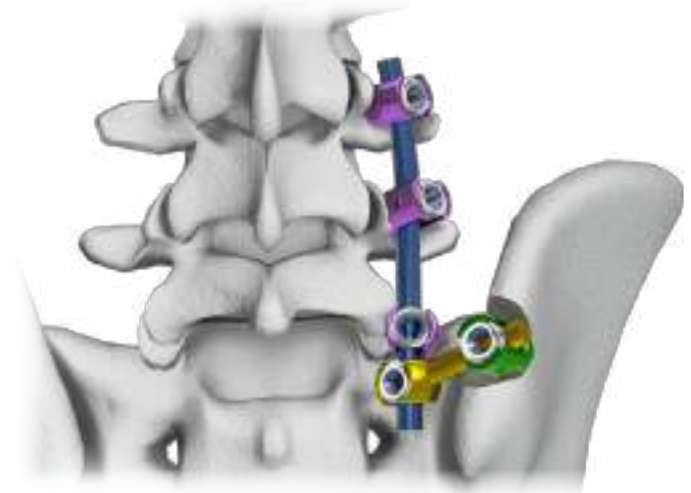

## 4.9. HOOKS INSERTION

### 4.9.1. PEDICLE HOOKS INSERTION

Pedicle hook is used for fixation of thoracic vertebrae and it is recommended for spine section between T10 and T1 vertebrae. Pedicle hook is always inserted in rostral direction, so its split blade leans on the vertebral arch pedicle.

Place for pedicle hook insertion is prepared by a limited facetectomy. On the desired level, there are two incisions made on the surface of the inferior transverse process, enabling the access to the cartilage of the superior transverse process of the preceding vertebra.



40.8107.000

Hook insertion point may be prepared with the use of raspatory for pedicle hooks [40.8107.000] by careful insertion in slightly lateral direction (*in relation to the medial line*) until the pedicle is identified. It is vital not to penetrate medially the spine canal.



40.8101.000

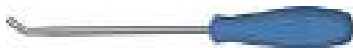

40.8103.000

When the place of insertion is ready, the hook is inserted with the help of hook holder [40.8101.000], and then it is carefully impacted to the desired position with the use of impactor for hooks [40.8103.000].

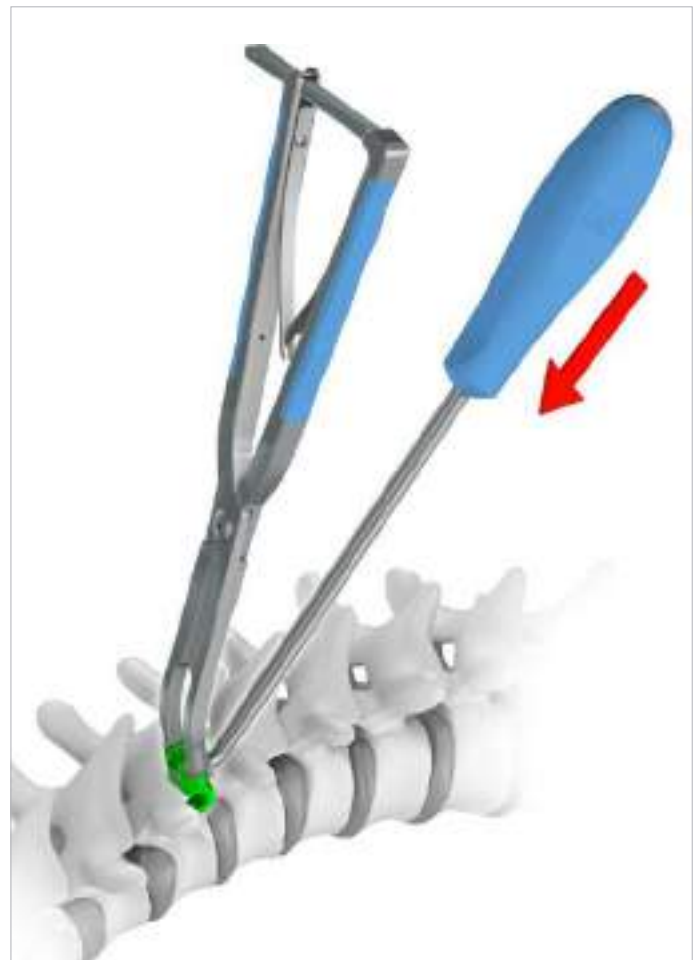



#### 4.9.2. INSERTION OF LAMINAR HOOKS

Laminar hooks are used in thoracolumbar spine. They may be inserted in rostral or caudal direction, depending on the spine section instrumented. A wide range of laminar hooks is available. The selection of appropriate hooks depends on the anatomy of the insertion point:

- in case of a hook inserted in caudal direction (*supralaminar manner*), it is recommended to use the thoracic hook with narrow blade to avoid excessive penetration of the spine canal with the hook blade.
- offset laminar hooks are recommended in situations when standard hooks do not ensure collinearity of inserted implants.
- extended laminar hooks are used in situation when a specific height (*in relation to other implants*) has to be maintained.

Laminar hook blade is inserted in space above the dura mater. To allow for appropriate passage of hook in spinal canal, a ligamentum flavum is removed and a limited laminectomy is performed.

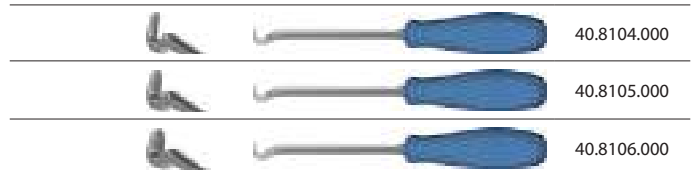

During the preparation of space for hooks the following raspatories for laminar hooks may be used:

- narrow [40.8104.000],
- standard [40.8105.000],
- wide [40.8106.000].

Blade widths correspond to widths of laminar hooks available.



The selected hook is mounted in jaws of a hook holder [40.8101.000] and then implanted in a prepared site in vertebral pedicle.



40.8101.000



40.8102.000

Alternatively, the selected hook may be mounted in jaws of lateral hook holder [40.8102.000], e.g. in situation when anatomical structure hinders the use of a holder [40.8101.000].

#### 4.9.3. INSERTION OF TRANSVERSE PROCESS HOOKS

Transverse process hooks are often used in thoracic spine region because of fairly large size of transverse process. Hooks may be inserted in rostral or caudal position. When the hook is inserted on a transverse process in caudal direction, it may be used for insertion (*in one line*) with inferiorly inserted pedicle hook to achieve an appropriate fixation and to ensure better stability.

Therefore, between the transverse process and the rib in front of the process, an upper and front surface of the transverse process is prepared with the use of raspator for laminar hooks [40.8105.000].

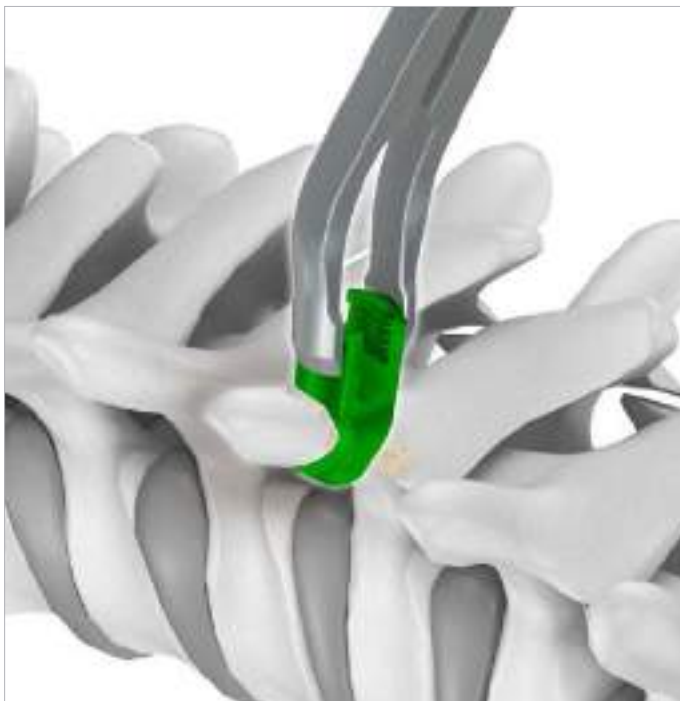

40.8105.000



40.8101.000

Mount the selected hook on a hook holder [40.8101.000] and then insert it on a prepared transverse process.

## 4.10. INSERTION OF SCREWS - ANTEROLATERAL APPROACH

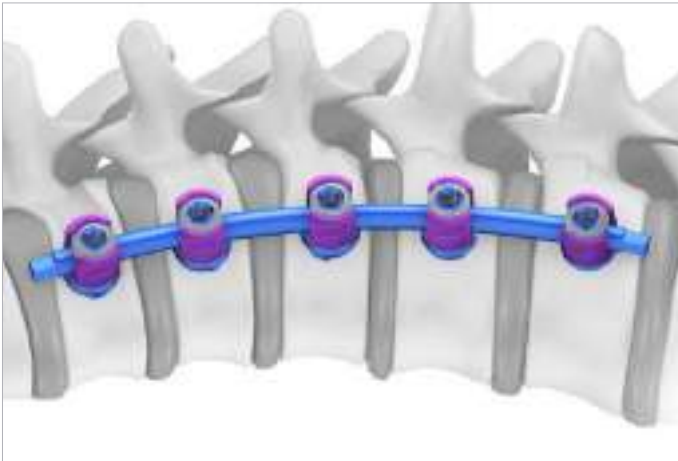

In general, the anterior approach is used for treatment of single-arch scolioses situated in thoracic or thoracolumbar spine. **CHARSPINE2** is designed to ensure single- and dual-rod stabilization with an open method by thoracotomy or thoracolumbar approach (*abdominal*).



It is recommended to use a dual-rod system because of a higher strength and stability. However, during the treatment of thoracic scolioses the insertion of two screws into each vertebral pedicle may be anatomically difficult, especially in upper and medial thoracic vertebrae. In such case a single-rod stabilization, or a single-rod stabilization for proximal segments and dual-rod stabilization for distal segments may be used.

The implantation begins with the insertion of single- and double-hole staples (*depending on the instrumented spine level*).

Both single- and double-hole staples evenly distribute the pressure on the surface of vertebrae pedicles and prevent splintering of vertebrae pedicles during corrective manipulation.

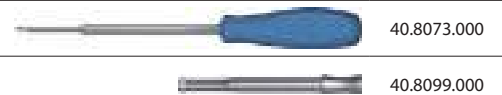

Single-hole staples are inserted and positioned with the use of a trocar [40.8073.000] with a staple holder [40.8099.00] attached.





Double-hole staples are inserted and positioned with the help of an impactor for staples [40.8098.000].



If necessary, the staples may be impacted to reach the desired position. Impaction is to be performed with the help of a metal hole plug on the handle of impactor for staples.



Screw insertion point should be prepared with the help of a trocar [40.8073.000] which penetrates the cortex of the vertebral body in the center of the staple hole.

When the spinal column is approached from the left side (*lumbar section*), the double-hole staples are marked for better understanding: letter R (for staples oriented rostrally) and letter C (for staples oriented caudally).

When the right-sided approach is used (*thoracic section*), the orientation of staples should be reversed: staples with letter R should be oriented caudally, while staples with C - rostrally.

In addition, the staples are marked with letters A (ANTERIOR) and P (POSTERIOR) to allow establishing the correct staples positioning during the insertion.

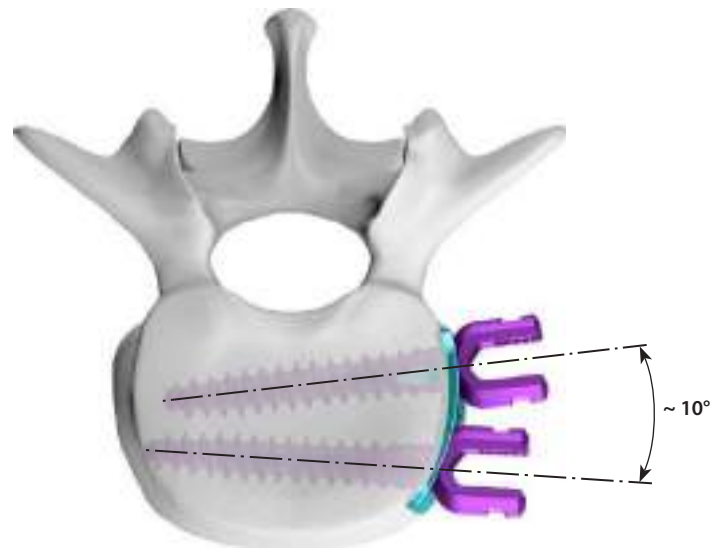

When the double-hole staples are used, the screws should be inserted at the angle of approximately 10° (in relation to each other) to allow for appropriate purchase in the bone.



To avoid any screw penetration in direction of the spine canal the staple should not be inserted too far into the anterior direction.



The insertion and locking of screws is performed in the same manner as already described in chapter INSERTION OF SCREWS - ANTERIOR APPROACH

#### 4.11. IMPLANT REMOVAL

To perform revision, the following steps should be taken (*observing the order provided*).

1. Use the screwdriver T30 [40.8111.000] to loosen and remove the locking screws.
2. Use the pliers for rod [40.8109.000] to remove the rods.
3. Remove the anchoring implants (*transpedicular screws or hooks*). Depending on the implant inserted use either the wrench for monoaxial screws [40.8089.100], wrench for polyaxial screws [40.8090.100] or hook holder [40.8101.000].



## 4.12. CEMENT AUGMENTATION OF SCREWS (OPTIONAL)

If bone cement is to be injected into the vertebral body, use fenestrated screws offered in a separate ChM implants system - CHARSPINE2 MIS (catalog pages for fenestrated screws are provided in a separate surgical technique - ST-86).



### CAUTION:

Use always guide rod introduced into the pedicle to insert fenestrated screws. The implantation of the fenestrated screw without the use of the guide rod can cause the bone material to be forced into the cannula of the screw and, consequently, make cement injection hindered or impossible.



The procedure for fenestrated screws implantation described below requires the use of special, dedicated cannulated instruments, which are not a part of the basic instrument set for open stabilization [15.0907.001].

**For the instruments below to be supplied, please contact your local representative or ChM Sales Department.**

### 4.12.1. GUIDE ROD INSERTION

To insert the guide rod, use the trocar [40.8601.000]. Alternatively, a disposable trocar, size 13G can be used.

The trocar insertion point is located at the intersection of the line dividing the transverse processes in half and the line running along the lateral edge of the upper articular process.

Insert the trocar through the pedicle into the vertebral body until the desired depth is reached.



40.8601.000

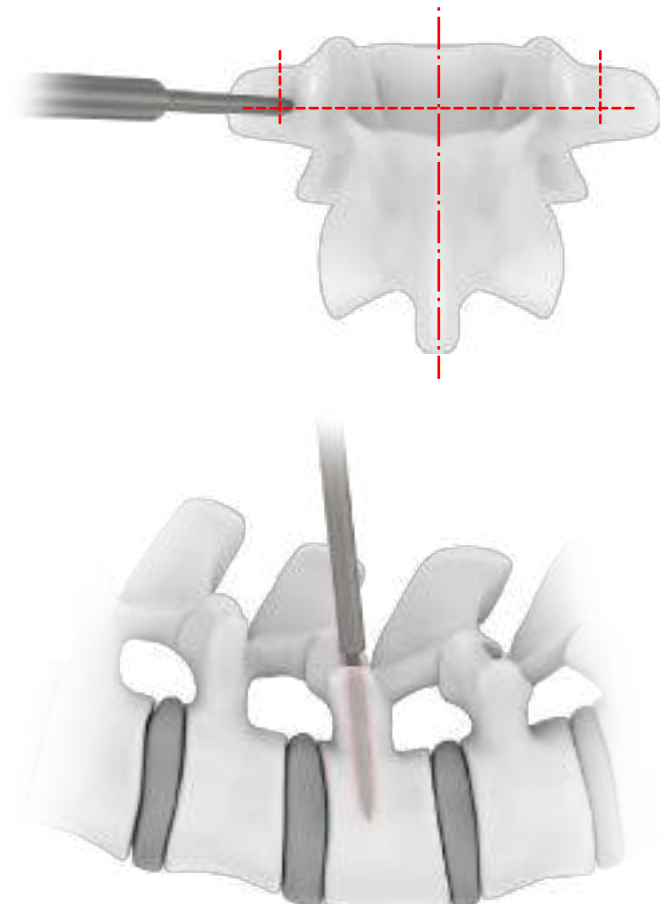

Make sure the trocar has been correctly inserted by taking lateral and A/P images.



The trocar is equipped with a depth limiter that determines the depth of insertion of the trocar tip. The depth limiter may also be used to determine the length of the screw to be used.

Depth of insertion

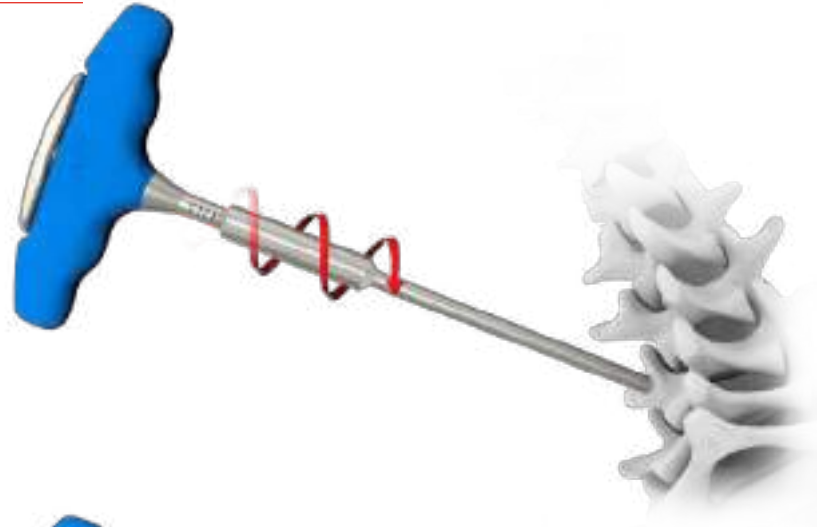

After trocar insertion, remove the pin.

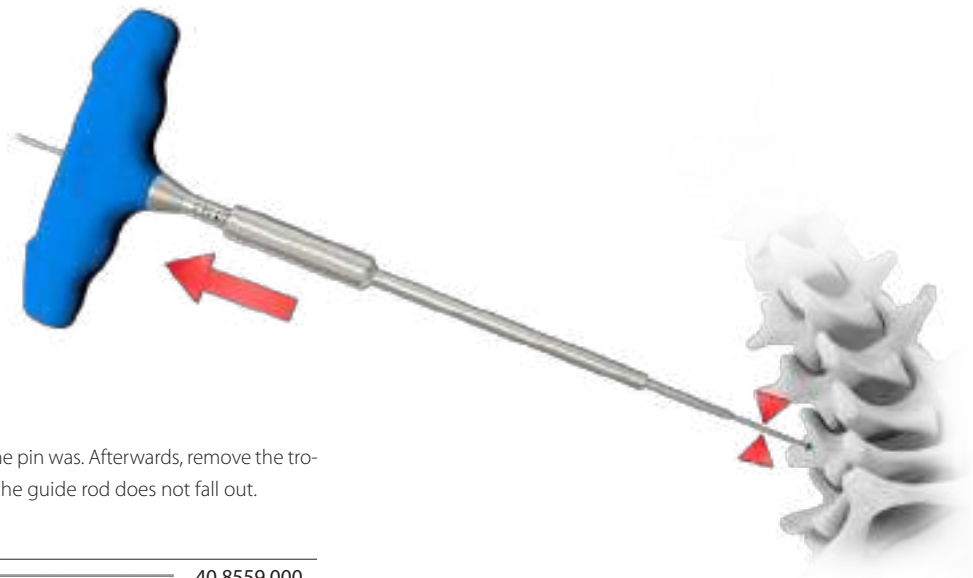
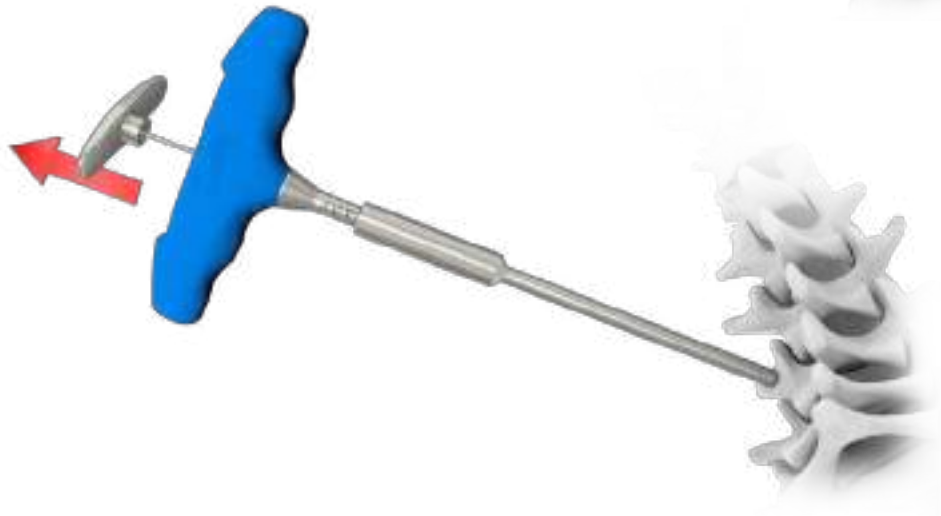

Insert the guide rod [40.8559.000] where the pin was. Afterwards, remove the trocar. When removing the trocar, make sure the guide rod does not fall out.

---



---

40.8559.000



4.12.2. HOLES THREADING (OPTIONAL)

**CHARSPINE2 MIS** fenestrated screws are self-tapping, therefore, in most cases, there is no need to thread the pedicles of vertebral arches. However, for clinical cases requiring threading, cortical taps [40.8567.045-40.8567.105] mounted in the oval head ratchet handle [40.8086.000] can be used.



4.12.3. SCREWS INSERTION

For fenestrated screws insertion, use cannulated wrench for polyaxial screws [40.6735.100] and oval head ratchet handle [40.8086.000].

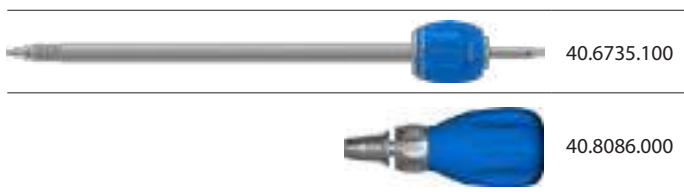

Choose the pedicle screw of correct length and diameter and install in the wrench.

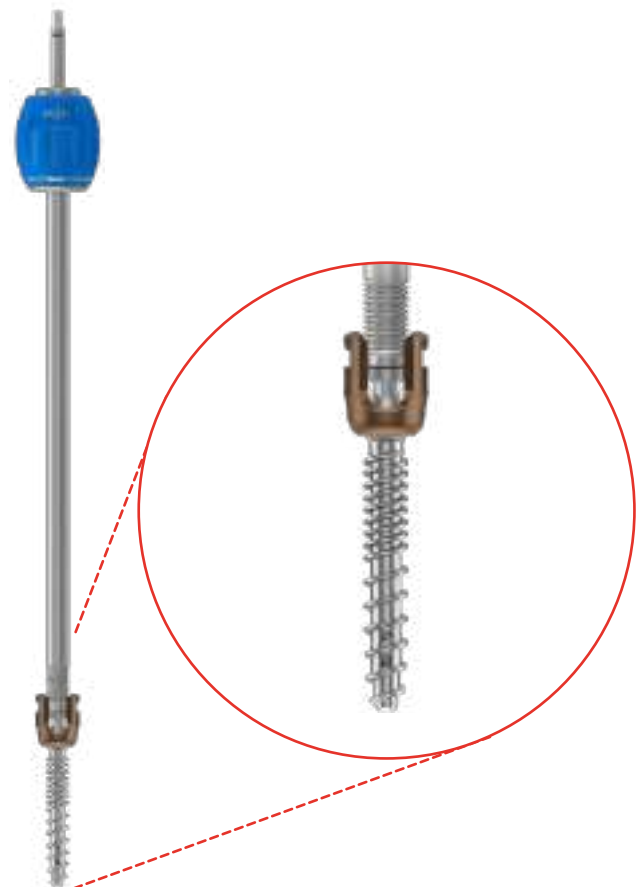

Turn the wrench knob clockwise to tighten the threaded outer sleeve of the wrench [40.6735.100] until the tip is fully seated in the bottom of the screw socket. The tightening direction is marked with an arrow and the word MOUNT. When tightening, with increasing resistance, the wrench knob will automatically move to the position that activates the mechanism preventing the screw from loosening.



Use the guide rod to insert the screw into the hole in the pedicle.



The screws insertion should be controlled in two planes using a fluoroscope.



It should be remembered that the correct screws positioning is achieved by screwing in the screws and not by screwing them out.

Backing the screw out may result in the loss of a stable anchoring and the need for use of a larger diameter screw.



When implanting the screw, do not hold the oval knob of the wrench, as this will disengage the safety mechanism.



If there is a need to use the other hand to hold the wrench, hold the part of the sleeve below the oval knob.

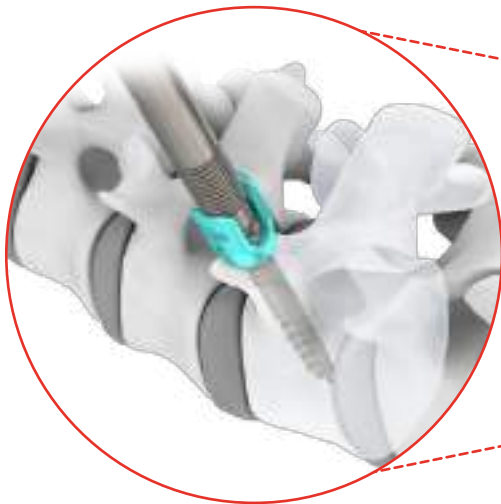
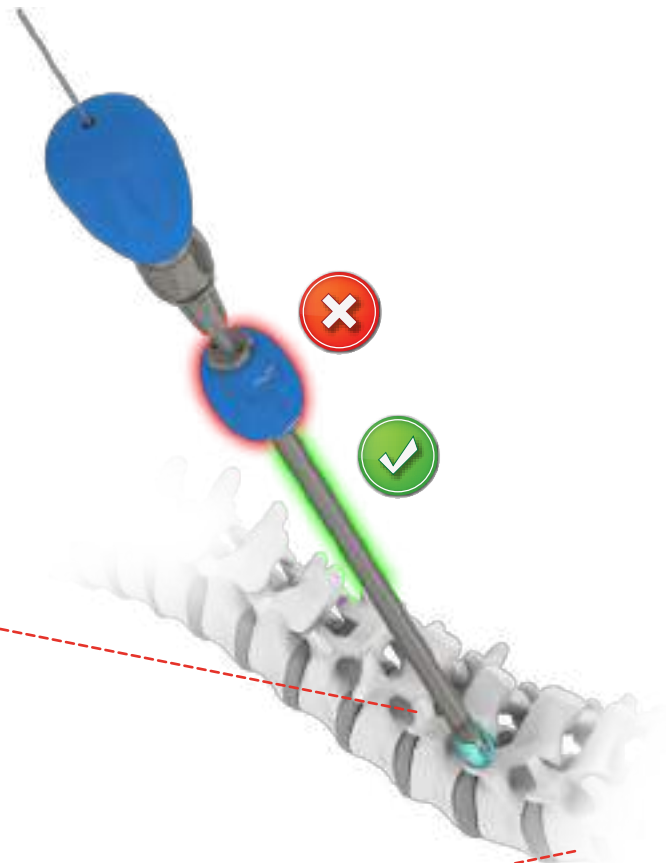

To remove the wrench [40.6735.100] from the screw, loosen the threaded sleeve of the wrench by turning the oval knob counterclockwise (*the direction is marked with an arrow and the word DISMOUNT*). When loosening, the wrench locking mechanism disengages automatically.



**CAUTION:**  
Do not remove the guide rod!



Repeat the steps described in chapter IV.12.3, and introduce the required number of screws.



#### 4.12.4. USE OF CANNULA FOR BONE CEMENT

For a bone cement to be injected into the vertebral body, install the cannula for bone cement [40.8591.000] to the implanted screw (before removing the guide rod). To do this, hold the flattened tip of the cannula and insert the other end, through the guide rod, into the screw head and then tightened it up (clockwise rotation).



While installing the cannula, use the counter wrench [40.6749.000] to immobilize the screw head.

To ensure the tightness of the connection, use the wrench [40.8580.000] for final tightening of the cannula.

Afterwards, the guide rod can be removed.

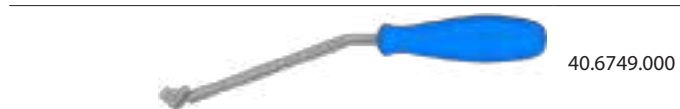

Should the screw been inserted so deep that the screw head was immobilized by the neighbouring bone, it may be necessary to slightly back out the screw to allow the head to move and the cannula to be properly inserted.



Incorrect connection of the cannula with the screw can cause cement leakage at the connection point. Only use ChM cannula for bone cement supply.

Before cement injection, all cannulas for bone cement should be attached to the screws.

#### 4.12.5. CEMENT PREPARATION AND INJECTION

For cement preparation, refer to the Instructions for Use for bone cement and cement mixing/delivery device system. The cannula for bone cement is equipped with a standardized Luer Lock thread, enabling a tight connection with the cement mixing/delivery device.



The volume of cement in the cannula [40.8594.000] is 0.8 ml.

Mix the cement as instructed and suck it into the cement mixing/delivery device. Before injecting, wait until the cement reaches the right viscosity.



Fluoroscopy should be used throughout the cement injection procedure to control the cement flow.

When using cement to augment multiple screws and levels, attention must be paid not to exceed the working time of the cement prior to completion of cement delivery through the screws. When the cement working time is close to complete, a new cement package should be used.



The cannula for bone cement as well as the mixing/delivery device are designed for use with one package of bone cement only. If a second package of cement is needed, use a new cannula and mixing/delivery device.

Do not attempt to force the injection of cement if excessive resistance is felt. Always determine the cause of the resistance and take appropriate action. If the cement is seen outside of the vertebral body or in the circulatory system during the procedure, immediately stop injecting the cement.

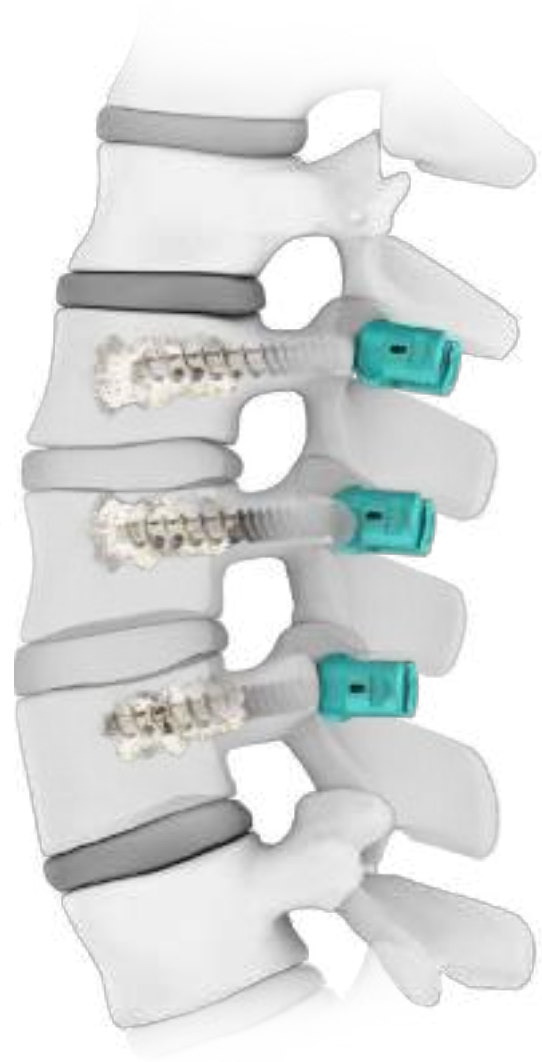

#### 4.12.6. REMOVAL OF THE CANNULA FOR BONE CEMENT

After cementing, unscrew the cannula from the screw. Hold the counter wrench [40.6749.000] with the other hand to counteract the removal process.

Back out the cement feeder slightly to ensure that after cementing and before removing the cannula from the screw, the cement flow has been stopped.



It is critical that no torsion movement should be applied to the screw after injecting the cement in order to avoid breaking the cement bridges between the screw and bone.

The cannula for bone cement and cement mixing/delivery device are disposable equipment and must be discarded after cementing.



 7715 NW 46th Street Doral, FL 33166, USA

 X: +1 (305) 675-8012

 sales@novutechusa.com

**NOVUTECH**  
[www.novutechusa.com](http://www.novutechusa.com)